



The Legacy
at Prospector
LP-17-00002

Source: Esri, DigitalGlobe, GeoEye, Earthstar Geographics, CNES/Airbus DS, USDA, USGS, AEX, Getmapping, Aerogrid, IGN, IGP, swisstopo, and the GIS User Community

LP-17-00002
The Legacy at Prospector

Aerial View

Critical Areas Checklist

Monday, April 03, 2017

Application File Number



Planner

Is SEPA required Yes No



Is Parcel History required? Yes No

What is the Zoning?



Is Project inside a Fire District? Yes No

If so, which one?



Is the project inside an Irrigation District? Yes No

If so, which one?

Does project have Irrigation Approval? Yes No

Which School District?

Is the project inside a UGA? Yes No

If so which one?

Is there FIRM floodplain on the project's parcel? Yes No

If so which zone?

What is the FIRM Panel Number?

Is the Project parcel in the Floodway? Yes No

Does the project parcel contain a shoreline of the State? Yes No

If so what is the Water Body?

What is the designation?

Does the project parcel contain a Classified Stream? Yes No

If so what is the Classification?

Does the project parcel contain a wetland? Yes No

If so what type is it?

Does the project parcel intersect a PHS designation? Yes No

If so, what is the Site Name?

Is there hazardous slope in the project parcel? Yes No

If so, what type?

Does the project parcel abut a DOT road? Yes No

If so, which one?

Does the project parcel abut a Forest Service road? Yes No

If so, which one?

Does the project parcel intersect an Airport overlay zone ? Yes No

If so, which Zone is it in?

Does the project parcel intersect a BPA right of way or line? Yes No

If so, which one?

Is the project parcel in or near a Mineral Resource Land? Yes No

If so, which one?

Is the project parcel in or near a DNR Landslide area? Yes No

If so, which one?

Is the project parcel in or near a Coal Mine area? Yes No

What is the Seismic Designation?

Does the Project Application have a Title Report Attached?

Does the Project Application have a Recorded Survey Attached?

Have the Current Years Taxes been paid?

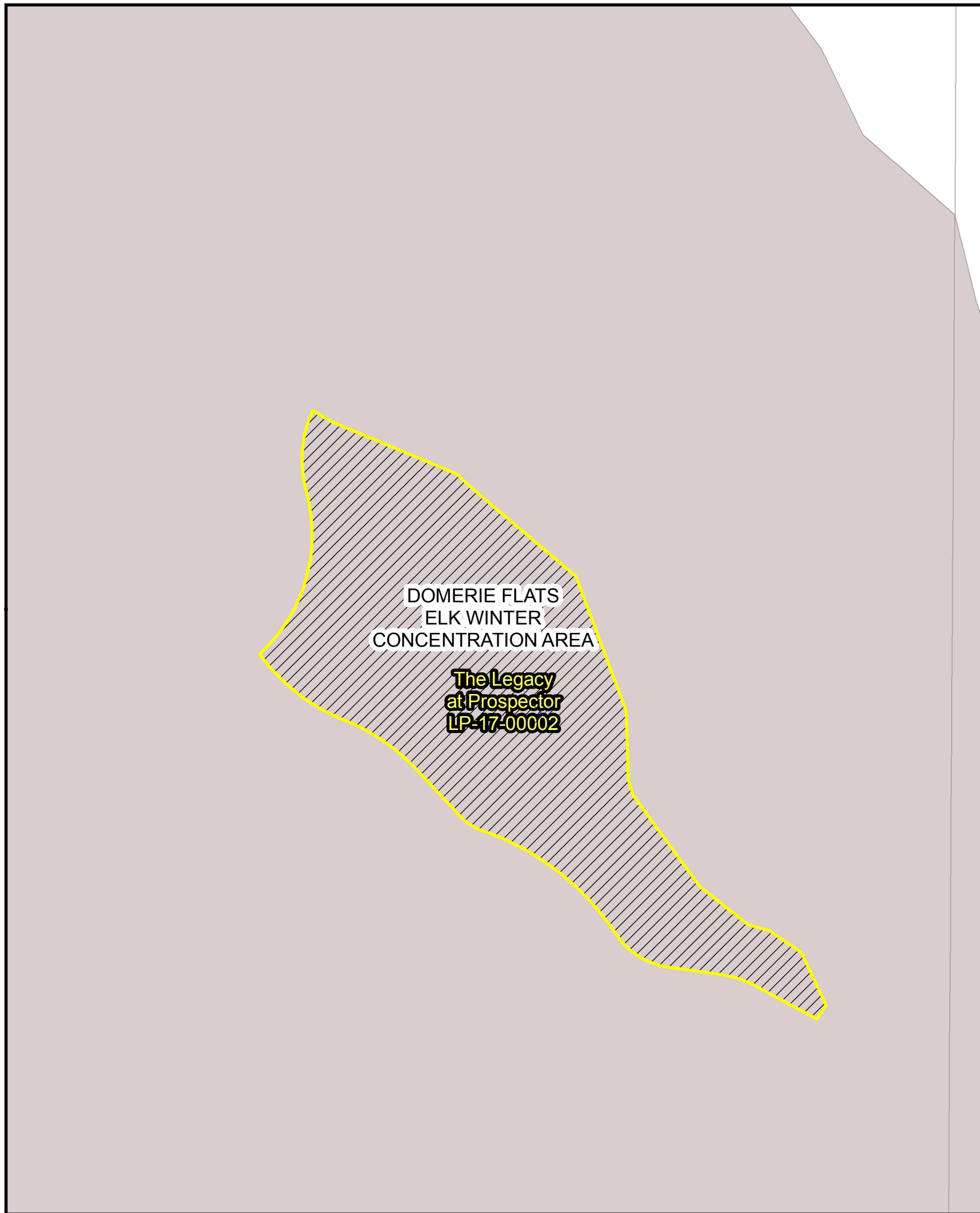

DOMERIE FLATS
ELK WINTER
CONCENTRATION AREA

**The Legacy
at Prospector
LP-17-00002**

LP-17-00002
The Legacy at Prospector

Priority Habitat

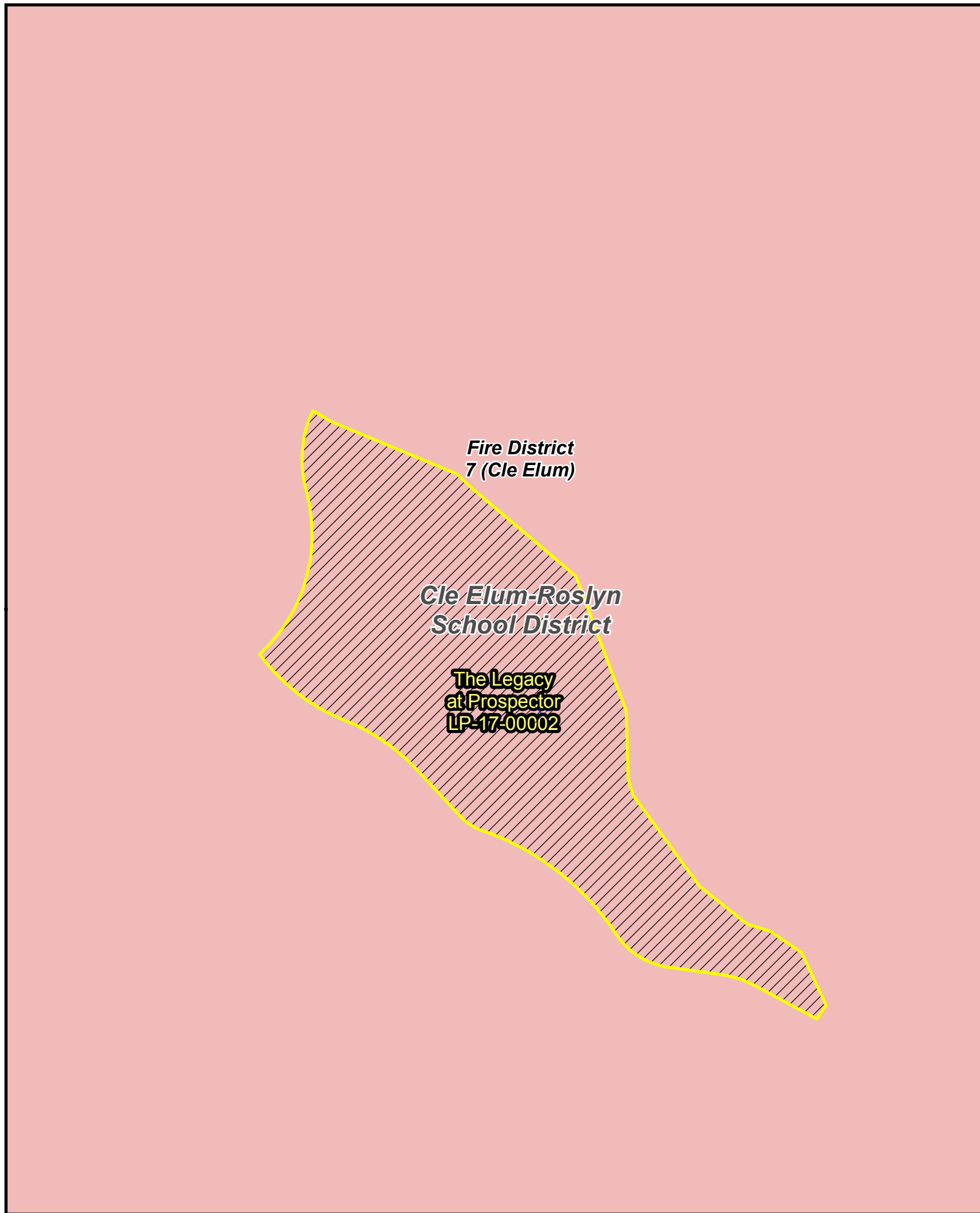

*Fire District
7 (Cle Elum)*

*Cle Elum-Roslyn
School District*

**The Legacy
at Prospector
LP-17-00002**

LP-17-00002
The Legacy at Prospector

District



LP-17-00002
The Legacy at Prospector

LP-17-00002
The Legacy at Prospector

Oblique View

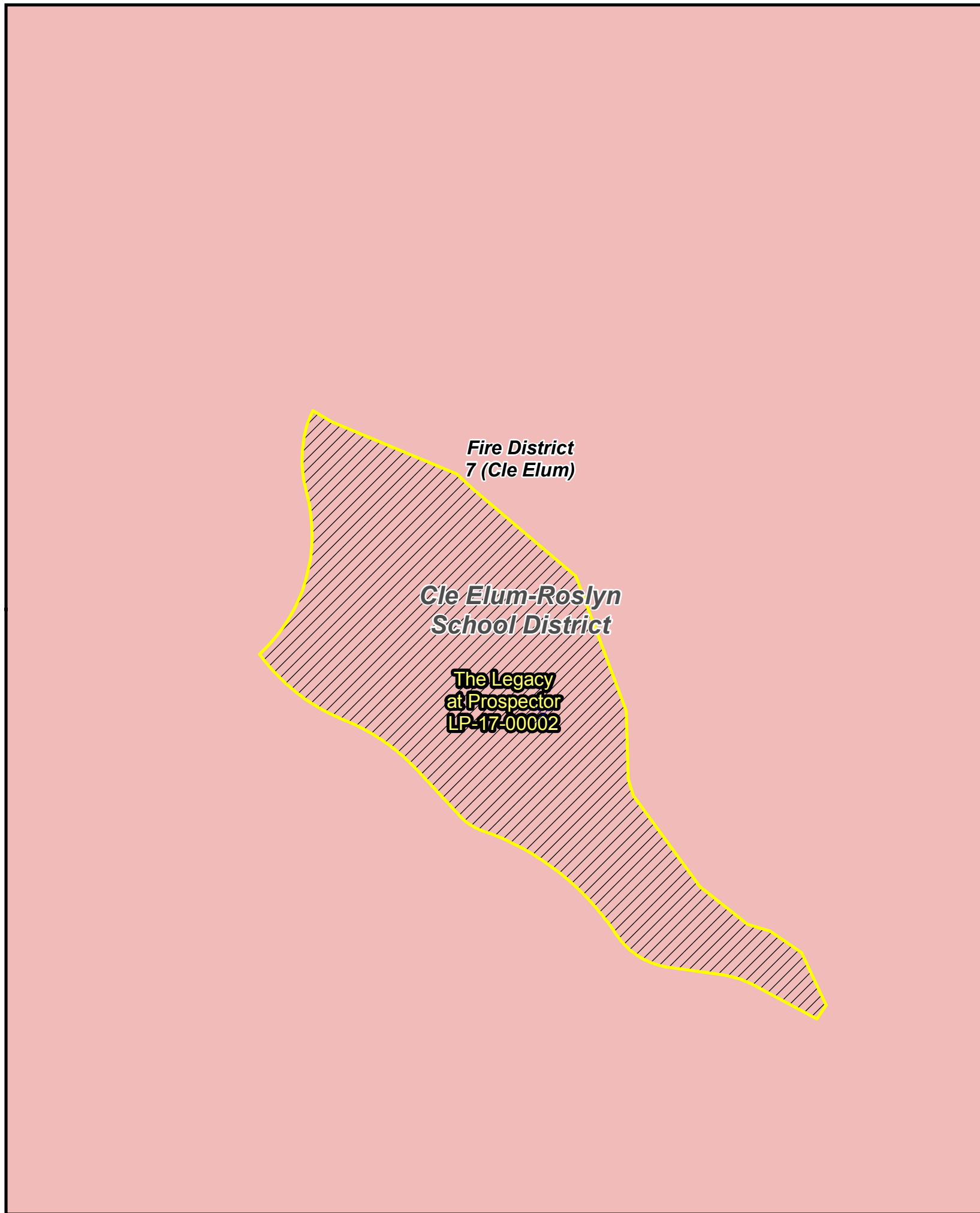

*Fire District
7 (Cle Elum)*

*Cle Elum-Roslyn
School District*

**The Legacy
at Prospector
LP-17-00002**

LP-17-00002
The Legacy at Prospector

Districts

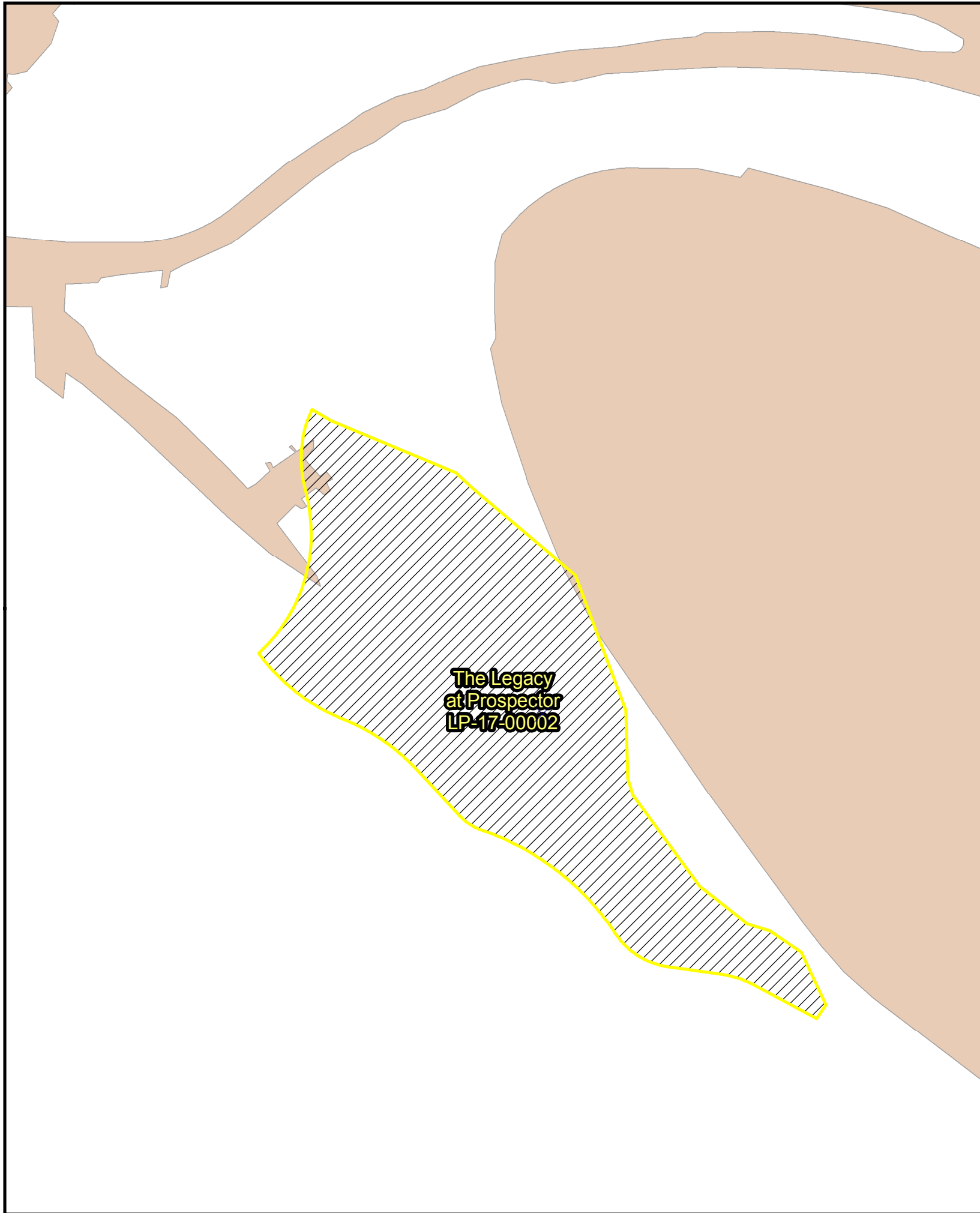

**The Legacy
at Prospector
LP-17-00002**

LP-17-00002
The Legacy at Prospector

Coal Mine Shaft Boundaries

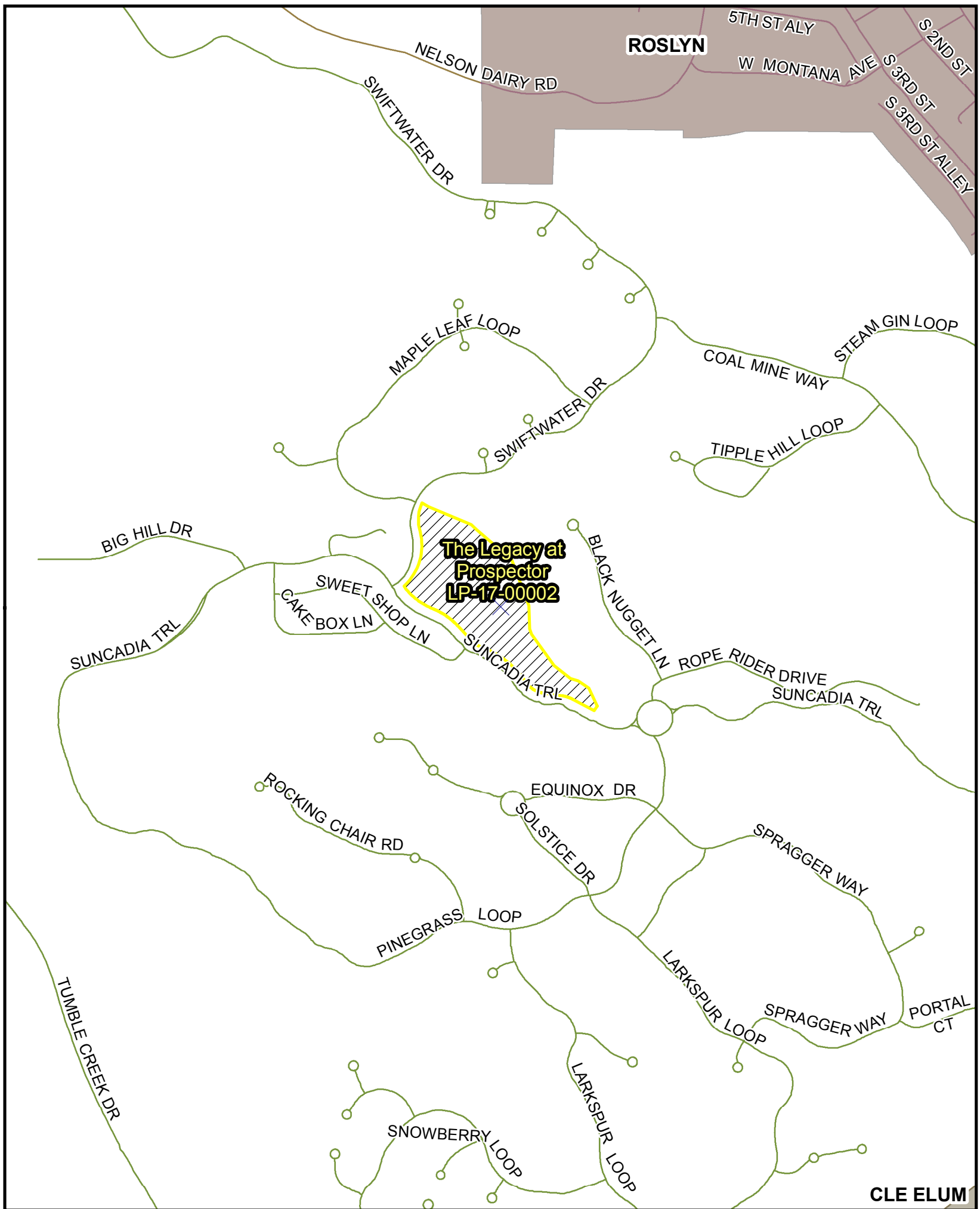

LP-17-00002
The Legacy at Prospector

Vicinity Map

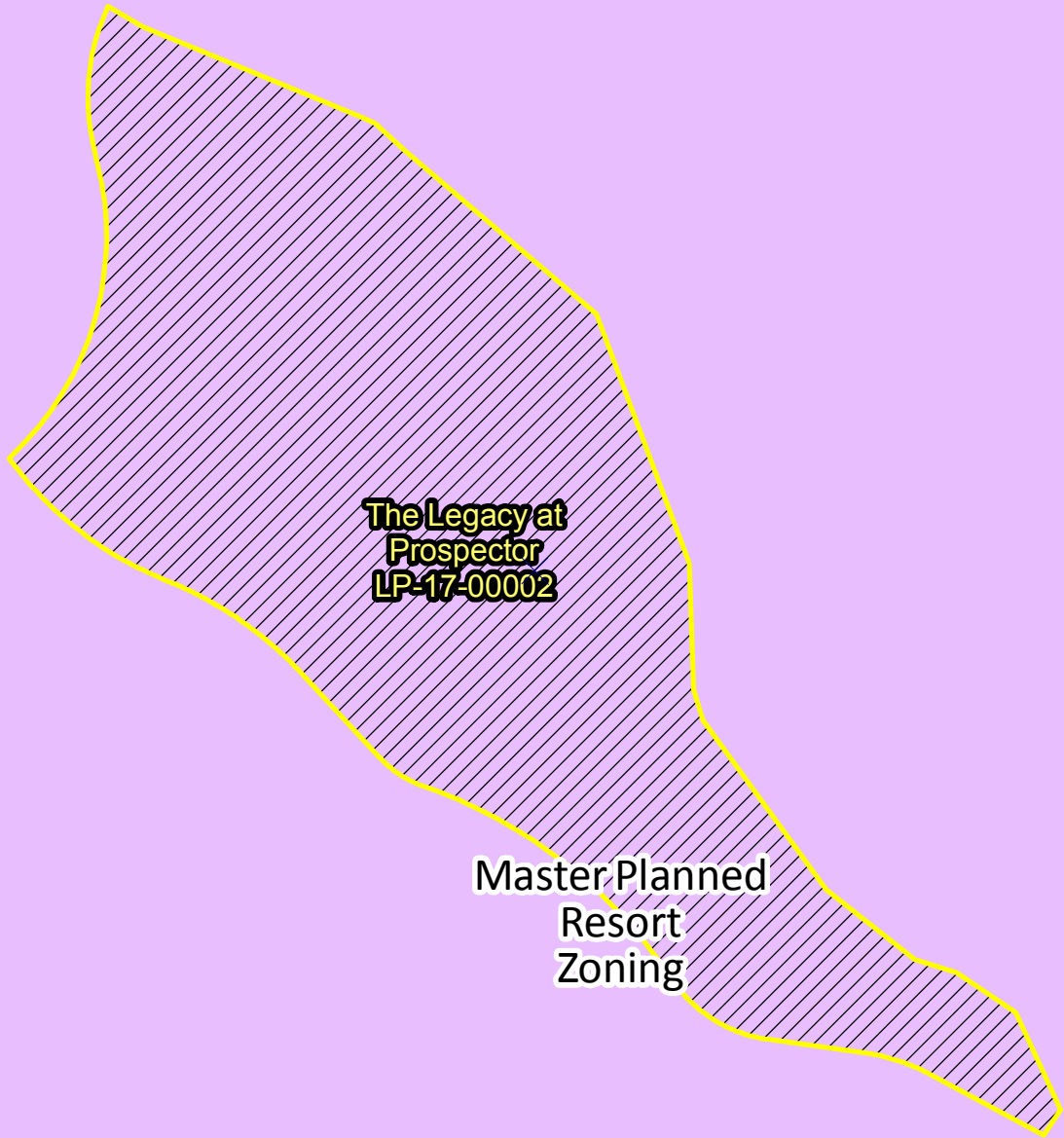

**The Legacy at
Prospector
LP-17-00002**

Master Planned
Resort
Zoning

LP-17-00002
The Legacy at Prospector

Zoning

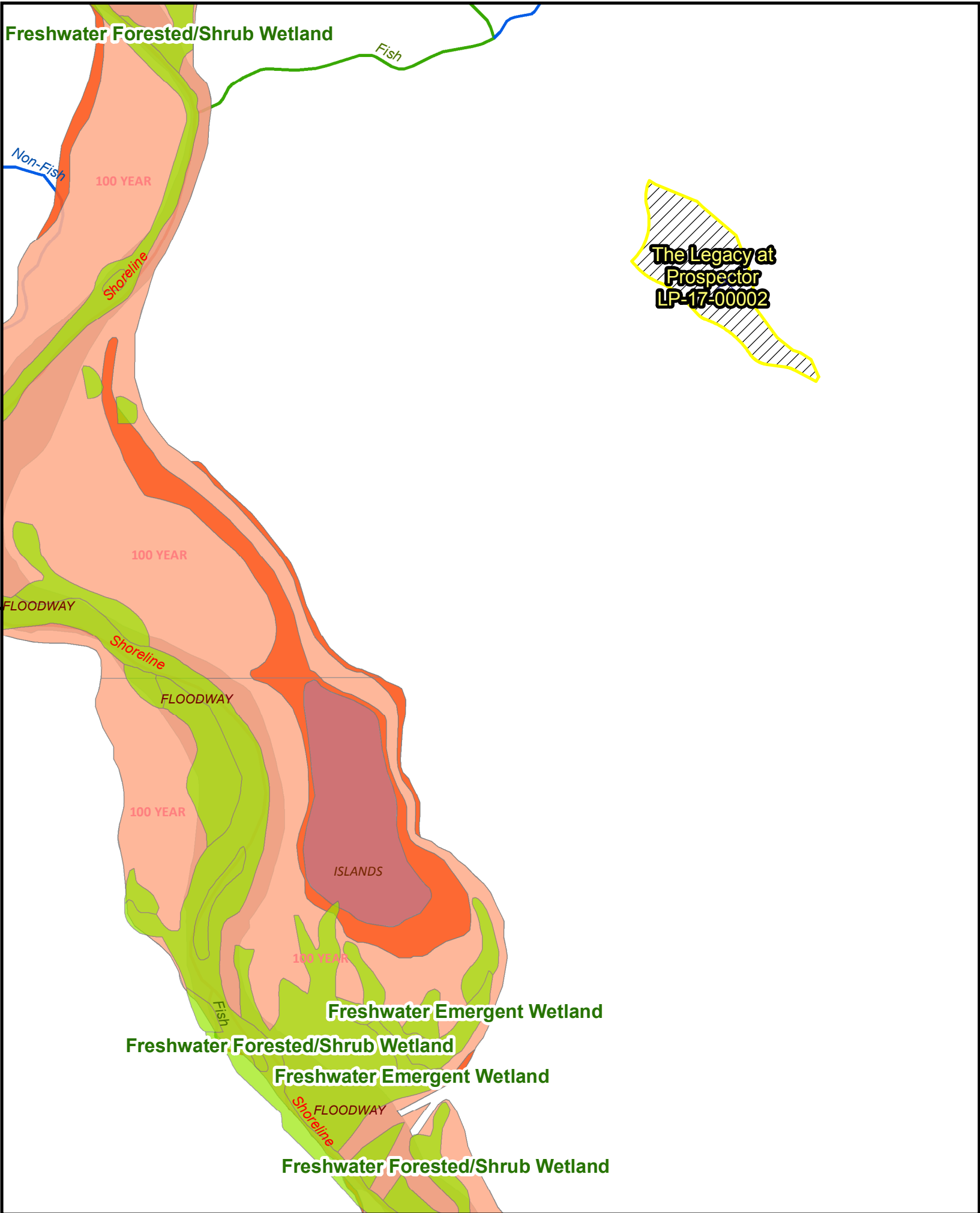

LP-17-00002
The Legacy at Prospector

Critical Areas



LP-17-00002
The Legacy at Prospector

Nearby Parcels



**The Legacy at Prospector
(Phase 1 Division 6)
Site Development Plan Application**

**Suncadia
Master Planned Resort**

**Owner/Developer: New Suncadia, L.L.C.
Cle Elum, Washington**

February 27, 2017

**ESM Consulting Engineers, LLC
33400 8th Avenue South, Suite 205
Federal Way, WA 98003**

**253.838.6113 tel
253.838.7104 fax**



www.esmcivil.com



February 27, 2017

Mr. Doc Hansen, Planning Official
Kittitas County Community Development Services
411 North Ruby Street, Suite 2
Ellensburg WA 98926

**RE: Suncadia The Legacy and Prospector (Phase 1 Division 6)
Site Development Plan and Preliminary Plat**

Dear Doc:

On behalf of New Suncadia, LLC., ESM Consulting Engineers LLC. is submitting 8 copies and a PDF on CD of the enclosed listed documents in support of The Legacy at Prospector (Phase 1 Division 6) Site Development Plan and Preliminary Plat:

- Long Plat Application
- SEPA Checklist and SEPA Attachment
- Site Development Plan Exhibit
- Project Narrative
- Preliminary Site and Utility Engineering Summary
- Exhibit M
- Conceptual Utility Exhibit
- Preliminary Plat Sheets
- Certificate of Title (Title Report)

In addition, the following information is also provided:

Owner of Record: New Suncadia LLC
770 Suncadia Trail
Cle Elum, WA 98922
509-649-3906
Contact: Mr. Cape Powers

Additional Authorized Agent: F. Steven Lathrop
Lathrop, Winbauer, Harrel, Slothower & Denison LLP
P. O. Box 1088
Ellensburg, WA 98926
509-925-6916

Mr. Doc Hansen
February 27, 2017
Page 2

Legal Description: Tract Z-2, Plat of "Suncadia Phase 1 Division 3", Auditor's File No. 200505040001, Being a portion of Sections 19 and 20, Township 20 North, Range 15 East, W.M., Kittitas County, State of Washington; together with that portion of Tract G-6 of said plat.

Tax Parcel Number: 20-15-20058-0184

Property Size: The parcel created by this application is 16.8 acres.

Sincerely,

ESM CONSULTING ENGINEERS, LLC.



LAURA BARTENHAGEN, P.E., LEED® AP
Principal

Enclosures

Cc: F. Steven Lathrop, LWHS (1 copy)
Cape Powers, New Suncadia LLC (2 copies)

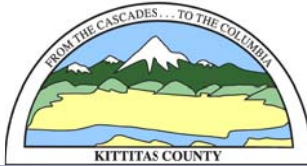

KITTITAS COUNTY COMMUNITY DEVELOPMENT SERVICES

411 N. Ruby St., Suite 2, Ellensburg, WA 98926

CDS@CO.KITTITAS.WA.US

Office (509) 962-7506

Fax (509) 962-7682

"Building Partnerships – Building Communities"

LONG PLAT APPLICATION

(To divide lot into 5 or more lots, per KCC Title 16)

A **preapplication conference is REQUIRED if proposing more than nine (9) lots per KCC 15A.03.020 for this permit.** The more information the County has early in the development process, the easier it is to identify and work through issues and conduct an efficient review. To schedule a preapplication conference, complete and submit a Preapplication Conference Scheduling Form to CDS. Notes or summaries from preapplication conference should be included with this application.

Please type or print clearly in ink. Attach additional sheets as necessary. Pursuant to KCC 15A.03.040, a complete application is determined within 28 days of receipt of the application submittal packet and fee. The following items must be attached to the application packet.

REQUIRED ATTACHMENTS

- Eight large copies of plat with all preliminary drawing requirements complete (reference KCC Title 16 Subdivision Code for plat drawing requirements) and one small 8.5" x 11" copy
- SEPA Checklist (if not exempt per KCC 15.04 or WAC 197-11-800)
 - o Please pick up a copy of the SEPA Checklist if required
- Project Narrative responding to Questions 9-11 on the following pages.

OPTIONAL ATTACHMENTS

(Optional at preliminary submittal, but required at the time of final submittal)

- Certificate of Title (Title Report)
- Computer lot closures

APPLICATION FEES:

\$4,900.00	Kittitas County Community Development Services (KCCDS) *Preliminary Plat Fee
\$602.00	Kittitas County Department of Public Works
\$524.00	Kittitas County Fire Marshal
\$540.00	Public Health Proportion (Additional fee of \$75/hour over 12.5 hours)
\$6,566.00	Total fees due for this application submittal (One check made payable to KCCDS)

\$950.00	Kittitas County Community Development Services (KCCDS) *Final Plat Fee
\$950.00	Total fees due for final plat processing

FOR STAFF USE ONLY

Application Received By (CDS Staff Signature): _____	DATE: _____	RECEIPT # _____
		<div style="border: 1px solid black; width: 100%; height: 100%;"></div> <p>DATE STAMP IN BOX</p>

GENERAL APPLICATION INFORMATION

1. Name, mailing address and day phone of land owner(s) of record:

Landowner(s) signature(s) required on application form.

Name: New Suncadia LLC
Mailing Address: 770 Suncadia Trail
City/State/ZIP: Cle Elum, WA 98922
Day Time Phone: 509-649-3906
Email Address: cpowers@suncadia.com

2. Name, mailing address and day phone of authorized agent, if different from landowner of record:

If an authorized agent is indicated, then the authorized agent's signature is required for application submittal.

Agent Name: F. Steven Lathrop
Mailing Address: P.O. Box 1088
City/State/ZIP: Ellensburg, WA 98926
Day Time Phone: 509-925-6916
Email Address: steve@lwhsd.com

3. Name, mailing address and day phone of other contact person

If different than land owner or authorized agent.

Name: _____
Mailing Address: _____
City/State/ZIP: _____
Day Time Phone: _____
Email Address: _____

4. Street address of property:

Address: East of intersection of Suncadia Trail and Swiftwater Drive
City/State/ZIP: Cle Elum, WA 98922-8717

5. Legal description of property (attach additional sheets as necessary):

See Preliminary Plat Documents.

6. Tax parcel number: 20-15-20058-0184

7. Property size: 16.8 (acres)

8. Land Use Information:

Zoning: Master Planned Resort Comp Plan Land Use Designation: Resort Residential

PROJECT NARRATIVE

(INCLUDE RESPONSES AS AN ATTACHMENT TO THIS APPLICATION)

- 9. **Narrative project description (include as attachment):** Please include at minimum the following information in your description: describe project size, location, water supply, sewage disposal and all qualitative features of the proposal; include every element of the proposal in the description.
- 10. **Are Forest Service roads/easements involved with accessing your development?** Yes (Circle) No
If yes, explain: _____
- 11. **What County maintained road(s) will the development be accessing from?**
Bullfrog Road.

AUTHORIZATION

- 12. Application is hereby made for permit(s) to authorize the activities described herein. I certify that I am familiar with the information contained in this application, and that to the best of my knowledge and belief such information is true, complete, and accurate. I further certify that I possess the authority to undertake the proposed activities. I hereby grant to the agencies to which this application is made, the right to enter the above-described location to inspect the proposed and or completed work.

All correspondence and notices will be transmitted to the Land Owner of Record and copies sent to the authorized agent or contact person, as applicable.

Signature of Land Owner of Record (required for application submittal):

NEW SUNCADIA, LLC,
A Delaware Limited Liability Company

By: Suncadia Operating Member, LLC,
A Delaware Limited Liability Company,
Its: Managing Member

By: LDD Suncadia Manager, Inc.,
A Delaware Corporation
Its: Manager

By: JOE T WALSH Date 2/22/17
Its: SENIOR VICE PRESIDENT

By: GARY A KITTLESON Date 2/22/17
Its: VICE PRESIDENT

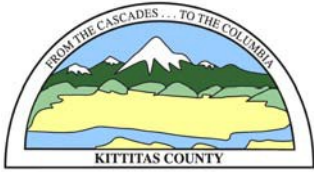

KITTITAS COUNTY COMMUNITY DEVELOPMENT SERVICES

411 N. Ruby St., Suite 2, Ellensburg, WA 98926

CDS@CO.KITTITAS.WA.US

Office (509) 962-7506

Fax (509) 962-7682

"Building Partnerships – Building Communities"

SEPA ENVIRONMENTAL CHECKLIST

Purpose of checklist:

Governmental agencies use this checklist to help determine whether the environmental impacts of your proposal are significant. This information is also helpful to determine if available avoidance, minimization or compensatory mitigation measures will address the probable significant impacts or if an environmental impact statement will be prepared to further analyze the proposal.

Instructions for applicants:

This environmental checklist asks you to describe some basic information about your proposal. Please answer each question accurately and carefully, to the best of your knowledge. You may need to consult with an agency specialist or private consultant for some questions. You may use "not applicable" or "does not apply" only when you can explain why it does not apply and not when the answer is unknown. You may also attach or incorporate by reference additional studies reports. Complete and accurate answers to these questions often avoid delays with the SEPA process as well as later in the decision-making process.

The checklist questions apply to all parts of your proposal, even if you plan to do them over a period of time or on different parcels of land. Attach any additional information that will help describe your proposal or its environmental effects. The agency to which you submit this checklist may ask you to explain your answers or provide additional information reasonably related to determining if there may be significant adverse impact.

Instructions for Lead Agencies:

Please adjust the format of this template as needed. Additional information may be necessary to evaluate the existing environment, all interrelated aspects of the proposal and an analysis of adverse impacts. The checklist is considered the first but not necessarily the only source of information needed to make an adequate threshold determination. Once a threshold determination is made, the lead agency is responsible for the completeness and accuracy of the checklist and other supporting documents.

Use of checklist for nonproject proposals: [\[help\]](#)

For nonproject proposals (such as ordinances, regulations, plans and programs), complete the applicable parts of sections A and B plus the [SUPPLEMENTAL SHEET FOR NONPROJECT ACTIONS \(part D\)](#). Please completely answer all questions that apply and note that the words "project," "applicant," and "property or site" should be read as "proposal," "proponent," and "affected geographic area," respectively. The lead agency may exclude (for non-projects) questions in Part B - Environmental Elements –that do not contribute meaningfully to the analysis of the proposal.

APPLICATION FEES:

\$600.00 Kittitas County Community Development Services (KCCDS)

\$70.00 Kittitas County Department of Public Works

\$670.00 Total fees due for this application (One check made payable to KCCDS)

FOR STAFF USE ONLY

Application Received by (CDS Staff Signature): <hr/>	DATE: <hr/>	RECEIPT# <hr/>	<div style="border: 1px solid black; width: 100%; height: 100%;"></div> <p style="text-align: center; font-size: small;">DATE STAMP IN BOX</p>
--	---------------------------	------------------------------	--

A. Background [\[help\]](#)

1. Name of proposed project, if applicable: [\[help\]](#)

2. Name of applicant: [\[help\]](#)

3. Address and phone number of applicant and contact person: [\[help\]](#)

4. Date checklist prepared: [\[help\]](#)

5. Agency requesting checklist: [\[help\]](#)

6. Proposed timing or schedule (including phasing, if applicable): [\[help\]](#)

7. Do you have any plans for future additions, expansion, or further activity related to or connected with this proposal? If yes, explain. [\[help\]](#)

8. List any environmental information you know about that has been prepared, or will be prepared, directly related to this proposal. [\[help\]](#)

9. Do you know whether applications are pending for governmental approvals of other proposals directly affecting the property covered by your proposal? If yes, explain. [\[help\]](#)

10. List any government approvals or permits that will be needed for your proposal, if known. [\[help\]](#)

11. Give brief, complete description of your proposal, including the proposed uses and the size of the project and site. There are several questions later in this checklist that ask you to describe certain aspects of your proposal. You do not need to repeat those answers on this page. (Lead agencies may modify this form to include additional specific information on project description.) [\[help\]](#)

12. Location of the proposal. Give sufficient information for a person to understand the precise location of your proposed project, including a street address, if any, and section, township, and range, if known. If a proposal would occur over a range of area, provide the range or boundaries of the site(s). Provide a legal description, site plan, vicinity map, and topographic map, if reasonably available. While you should submit any plans required by the agency, you are not required to duplicate maps or detailed plans submitted with any permit applications related to this checklist. [\[help\]](#)

B. ENVIRONMENTAL ELEMENTS [\[help\]](#)

1. Earth [\[help\]](#)

a. General description of the site: [\[help\]](#)

(circle one): Flat, rolling hilly, steep slopes, mountainous, other _____

b. What is the steepest slope on the site (approximate percent slope)? [\[help\]](#)

c. What general types of soils are found on the site (for example, clay, sand, gravel, peat, muck)? If you know the classification of agricultural soils, specify them and note any agricultural land of long-term commercial significance and whether the proposal results in removing any of these soils. [\[help\]](#)

d. Are there surface indications or history of unstable soils in the immediate vicinity? If so, describe. [\[help\]](#)

e. Describe the purpose, type, total area, and approximate quantities and total affected area of any filling, excavation, and grading proposed. Indicate source of fill. [\[help\]](#)

f. Could erosion occur as a result of clearing, construction, or use? If so, generally describe. [\[help\]](#)

g. About what percent of the site will be covered with impervious surfaces after project construction (for example, asphalt or buildings)? [\[help\]](#)

h. Proposed measures to reduce or control erosion, or other impacts to the earth, if any: [\[help\]](#)

2. Air [\[help\]](#)

a. What types of emissions to the air would result from the proposal during construction, operation, and maintenance when the project is completed? If any, generally describe and give approximate quantities if known. [\[help\]](#)

b. Are there any off-site sources of emissions or odor that may affect your proposal? If so, generally describe. [\[help\]](#)

c. Proposed measures to reduce or control emissions or other impacts to air, if any: [\[help\]](#)

3. **Water** [\[help\]](#)

a. Surface Water:

- 1) Is there any surface water body on or in the immediate vicinity of the site (including year-round and seasonal streams, saltwater, lakes, ponds, wetlands)? If yes, describe type and provide names. If appropriate, state what stream or river it flows into. [\[help\]](#)

- 2) Will the project require any work over, in, or adjacent to (within 200 feet) the described waters? If yes, please describe and attach available plans. [\[help\]](#)

- 3) Estimate the amount of fill and dredge material that would be placed in or removed from surface water or wetlands and indicate the area of the site that would be affected. Indicate the source of fill material. [\[help\]](#)

- 4) Will the proposal require surface water withdrawals or diversions? Give general description, purpose, and approximate quantities if known. [\[help\]](#)

- 5) Does the proposal lie within a 100-year floodplain? If so, note location on the site plan. [\[help\]](#)

- 6) Does the proposal involve any discharges of waste materials to surface waters? If so, describe the type of waste and anticipated volume of discharge. [\[help\]](#)

b. Ground Water:

- 1) Will groundwater be withdrawn from a well for drinking water or other purposes? If so, give a general description of the well, proposed uses and approximate quantities withdrawn from the well. Will water be discharged to groundwater? Give general description, purpose, and approximate quantities if known. [\[help\]](#)

- 2) Describe waste material that will be discharged into the ground from septic tanks or other sources, if any (for example: Domestic sewage; industrial, containing the following chemicals. . . ; agricultural; etc.). Describe the general size of the system, the number of such systems, the number of houses to be served (if applicable), or the number of animals or humans the system(s) are expected to serve. [\[help\]](#)

c. Water runoff (including stormwater):

1) Describe the source of runoff (including storm water) and method of collection and disposal, if any (include quantities, if known). Where will this water flow? Will this water flow into other waters? If so, describe. [\[help\]](#)

2) Could waste materials enter ground or surface waters? If so, generally describe. [\[help\]](#)

3) Does the proposal alter or otherwise affect drainage patterns in the vicinity of the site? If so, describe. [\[help\]](#)

d. Proposed measures to reduce or control surface, ground, and runoff water, and drainage pattern impacts, if any: [\[help\]](#)

4. Plants [\[help\]](#)

a. Check the types of vegetation found on the site: [\[help\]](#)

deciduous tree: alder, maple, aspen, other

evergreen tree: fir, cedar, pine, other

shrubs

grass

pasture

crop or grain

Orchards, vineyards or other permanent crops.

wet soil plants: cattail, buttercup, bullrush, skunk cabbage, other

water plants: water lily, eelgrass, milfoil, other

other types of vegetation

b. What kind and amount of vegetation will be removed or altered? [\[help\]](#)

c. List threatened and endangered species known to be on or near the site. [\[help\]](#)

d. Proposed landscaping, use of native plants, or other measures to preserve or enhance vegetation on the site, if any: [\[help\]](#)

e. List all noxious weeds and invasive species known to be on or near the site. [\[help\]](#)

5. Animals [\[help\]](#)

- a. List any birds and other animals which have been observed on or near the site or are known to be on or near the site. [\[help\]](#)

Examples include:

birds: hawk, heron, eagle, songbirds, other:

mammals: deer, bear, elk, beaver, other:

fish: bass, salmon, trout, herring, shellfish, other _____

- b. List any threatened and endangered species known to be on or near the site. [\[help\]](#)

- c. Is the site part of a migration route? If so, explain. [\[help\]](#)

- d. Proposed measures to preserve or enhance wildlife, if any: [\[help\]](#)

- e. List any invasive animal species known to be on or near the site. [\[help\]](#)

6. Energy and Natural Resources [\[help\]](#)

- a. What kinds of energy (electric, natural gas, oil, wood stove, solar) will be used to meet the completed project's energy needs? Describe whether it will be used for heating, manufacturing, etc. [\[help\]](#)

- b. Would your project affect the potential use of solar energy by adjacent properties? If so, generally describe. [\[help\]](#)

- c. What kinds of energy conservation features are included in the plans of this proposal? List other proposed measures to reduce or control energy impacts, if any: [\[help\]](#)

7. Environmental Health [\[help\]](#)

- a. Are there any environmental health hazards, including exposure to toxic chemicals, risk of fire and explosion, spill, or hazardous waste, that could occur as a result of this proposal? If so, describe. [\[help\]](#)

1) Describe any known or possible contamination at the site from present or past uses. [\[help\]](#)

2) Describe existing hazardous chemicals/conditions that might affect project development and

design. This includes underground hazardous liquid and gas transmission pipelines located within the project area and in the vicinity. [\[help\]](#)

3) Describe any toxic or hazardous chemicals that might be stored, used, or produced during the project's development or construction, or at any time during the operating life of the project. [\[help\]](#)

4) Describe special emergency services that might be required. [\[help\]](#)

5) Proposed measures to reduce or control environmental health hazards, if any: [\[help\]](#)

b. Noise [\[help\]](#)

1) What types of noise exist in the area which may affect your project (for example: traffic, equipment, operation, other)? [\[help\]](#)

2) What types and levels of noise would be created by or associated with the project on a short-term or a long-term basis (for example: traffic, construction, operation, other)? Indicate what hours noise would come from the site. [\[help\]](#)

3) Proposed measures to reduce or control noise impacts, if any: [\[help\]](#)

8. Land and Shoreline Use [\[help\]](#)

a. What is the current use of the site and adjacent properties? Will the proposal affect current land uses on nearby or adjacent properties? If so, describe. [\[help\]](#)

b. Has the project site been used as working farmlands or working forest lands? If so, describe. How much agricultural or forest land of long-term commercial significance will be converted to other uses as a result of the proposal, if any? If resource lands have not been designated, how many acres in farmland or forest land tax status will be converted to nonfarm or nonforest use? [\[help\]](#)

1) Will the proposal affect or be affected by surrounding working farm or forest land normal business operations, such as oversize equipment access, the application of pesticides, tilling, and harvesting? If so, how: [\[help\]](#)

c. Describe any structures on the site. [\[help\]](#)

- d. Will any structures be demolished? If so, what? [\[help\]](#)

- e. What is the current zoning classification of the site? [\[help\]](#)

- f. What is the current comprehensive plan designation of the site? [\[help\]](#)

- g. If applicable, what is the current shoreline master program designation of the site? [\[help\]](#)

- h. Has any part of the site been classified as a critical area by the city or county? If so, specify. [\[help\]](#)

- i. Approximately how many people would reside or work in the completed project? [\[help\]](#)

- j. Approximately how many people would the completed project displace? [\[help\]](#)

- k. Proposed measures to avoid or reduce displacement impacts, if any: [\[help\]](#)

- L. Proposed measures to ensure the proposal is compatible with existing and projected land uses and plans, if any: [\[help\]](#)

- m. Proposed measures to reduce or control impacts to agricultural and forest lands of long-term commercial significance, if any: [\[help\]](#)

9. **Housing** [\[help\]](#)

- a. Approximately how many units would be provided, if any? Indicate whether high, middle, or low-income housing. [\[help\]](#)

b. Approximately how many units, if any, would be eliminated? Indicate whether high, middle, or low-income housing. [\[help\]](#)

c. Proposed measures to reduce or control housing impacts, if any: [\[help\]](#)

10. Aesthetics [\[help\]](#)

a. What is the tallest height of any proposed structure(s), not including antennas; what is the principal exterior building material(s) proposed? [\[help\]](#)

b. What views in the immediate vicinity would be altered or obstructed? [\[help\]](#)

c. Proposed measures to reduce or control aesthetic impacts, if any: [\[help\]](#)

11. Light and Glare [\[help\]](#)

a. What type of light or glare will the proposal produce? What time of day would it mainly occur? [\[help\]](#)

b. Could light or glare from the finished project be a safety hazard or interfere with views? [\[help\]](#)

c. What existing off-site sources of light or glare may affect your proposal? [\[help\]](#)

d. Proposed measures to reduce or control light and glare impacts, if any: [\[help\]](#)

12. Recreation [\[help\]](#)

a. What designated and informal recreational opportunities are in the immediate vicinity? [\[help\]](#)

b. Would the proposed project displace any existing recreational uses? If so, describe. [\[help\]](#)

c. Proposed measures to reduce or control impacts on recreation, including recreation opportunities to be provided by the project or applicant, if any: [\[help\]](#)

13. Historic and cultural preservation [\[help\]](#)

- a. Are there any buildings, structures, or sites, located on or near the site that are over 45 years old listed in or eligible for listing in national, state, or local preservation registers ? If so, specifically describe. [\[help\]](#)

 - b. Are there any landmarks, features, or other evidence of Indian or historic use or occupation? This may include human burials or old cemeteries. Are there any material evidence, artifacts, or areas of cultural importance on or near the site? Please list any professional studies conducted at the site to identify such resources. [\[help\]](#)

 - c. Describe the methods used to assess the potential impacts to cultural and historic resources on or near the project site. Examples include consultation with tribes and the department of archeology and historic preservation, archaeological surveys, historic maps, GIS data, etc. [\[help\]](#)

 - d. Proposed measures to avoid, minimize, or compensate for loss, changes to, and disturbance to resources. Please include plans for the above and any permits that may be required. [\[help\]](#)
-

14. Transportation [\[help\]](#)

- a. Identify public streets and highways serving the site or affected geographic area and describe proposed access to the existing street system. Show on site plans, if any. [\[help\]](#)

- b. Is the site or affected geographic area currently served by public transit? If so, generally describe. If not, what is the approximate distance to the nearest transit stop? [\[help\]](#)

- c. How many additional parking spaces would the completed project or non-project proposal have? How many would the project or proposal eliminate? [\[help\]](#)

- d. Will the proposal require any new or improvements to existing roads, streets, pedestrian, bicycle or state transportation facilities, not including driveways? If so, generally describe (indicate whether public or private). [\[help\]](#)_____

- e. Will the project or proposal use (or occur in the immediate vicinity of) water, rail, or air transportation? If so, generally describe. [\[help\]](#)

- f. How many vehicular trips per day would be generated by the completed project or proposal? If known, indicate when peak volumes would occur and what percentage of the volume would be trucks (such as commercial and nonpassenger vehicles). What data or transportation models were used to make these estimates? [\[help\]](#)

g. Will the proposal interfere with, affect or be affected by the movement of agricultural and forest products on roads or streets in the area? If so, generally describe. [\[help\]](#)

No.

h. Proposed measures to reduce or control transportation impacts, if any: [\[help\]](#)

Please refer to the MPR Conditions of Approval, Sections C-1 through C-20B.

15. Public Services [\[help\]](#)

a. Would the project result in an increased need for public services (for example: fire protection, police protection, public transit, health care, schools, other)? If so, generally describe. [\[help\]](#)

There would be a small increase in demand for fire and police protection, schools, and health care facilities.

b. Proposed measures to reduce or control direct impacts on public services, if any. [\[help\]](#)

Measures are outlined in the MPR Conditions of Approval, Sections C-30 through C-47 would reduce impacts.

16. Utilities [\[help\]](#)

a. Circle utilities currently available at the site: [\[help\]](#)

electricity, natural gas, water, refuse service, telephone, sanitary sewer, ~~septic system~~,
other _____

All utilities listed above are available to the site.

b. Describe the utilities that are proposed for the project, the utility providing the service, and the general construction activities on the site or in the immediate vicinity which might be needed. [\[help\]](#)

Electricity, natural gas, telephone cable television, refuse, water, and sewer services are proposed at the site.

C. Signature [\[help\]](#)

The above answers are true and complete to the best of my knowledge. I understand that the lead agency is relying on them to make its decision.

Signature: _____

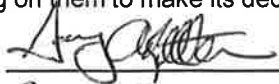

Name of signee _____

GARY A. KITTRESON

Position and Agency/Organization _____

VICE PRESIDENT OF LDD Suncadia Manager, Inc., manager of

Date Submitted: _____

2/22/17

Suncadia Operating Member, LLC, managing member of
New Suncadia, LLC

D. supplemental sheet for nonproject actions [\[help\]](#)

(IT IS NOT NECESSARY to use this sheet for project actions)

Because these questions are very general, it may be helpful to read them in conjunction with the list of the elements of the environment.

When answering these questions, be aware of the extent the proposal, or the types of activities likely to result from the proposal, would affect the item at a greater intensity or at a faster rate than if the proposal were not implemented. Respond briefly and in general terms.

1. How would the proposal be likely to increase discharge to water; emissions to air; production, storage, or release of toxic or hazardous substances; or production of noise?

Proposed measures to avoid or reduce such increases are:

2. How would the proposal be likely to affect plants, animals, fish, or marine life?

Proposed measures to protect or conserve plants, animals, fish, or marine life are:

3. How would the proposal be likely to deplete energy or natural resources?

Proposed measures to protect or conserve energy and natural resources are:

4. How would the proposal be likely to use or affect environmentally sensitive areas or areas designated (or eligible or under study) for governmental protection; such as parks, wilderness, wild and scenic rivers, threatened or endangered species habitat, historic or cultural sites, wetlands, floodplains, or prime farmlands?

Proposed measures to protect such resources or to avoid or reduce impacts are:

5. How would the proposal be likely to affect land and shoreline use, including whether it would allow or encourage land or shoreline uses incompatible with existing plans?

Proposed measures to avoid or reduce shoreline and land use impacts are:

6. How would the proposal be likely to increase demands on transportation or public services and utilities?

Proposed measures to reduce or respond to such demand(s) are:

7. Identify, if possible, whether the proposal may conflict with local, state, or federal laws or requirements for the protection of the environment.

**Attachment to
SEPA Environmental Checklist
The Legacy at Prospector (Phase 1 Division 6)**

Introduction

This attachment contains information requested on the Kittitas County SEPA Environmental Checklist which exceeded the area provided in the form.

A. BACKGROUND

3. LIST ANY ENVIRONMENTAL INFORMATION YOU KNOW ABOUT THAT HAD BEEN PREPARED, OR WILL BE PREPARED, DIRECTLY RELATED TO THIS PROPOSAL.

The following environmental information has been prepared for the Suncadia MPR Project:

- MountainStar Master Planned Resort Draft Environmental Impact Statement, Volumes I-III, July 1999. (“DEIS”)
- MountainStar Master Planned Resort Final Environmental Impact Statement, Volumes 1-4, April 2000. (“FEIS”)
- MountainStar Master Planned Resort Environmental Impact Statement Addendum, March 2002. (“EIS Addendum”)
- MountainStar Properties/Cle Elum Urban Growth Area Final Environmental Impact Statement, February 2002. (“Cle Elum FEIS”)

B. ENVIRONMENTAL ELEMENTS

1. EARTH

d. Are there surface indications or history of unstable soils in the immediate vicinity?

Potential landslide hazards are discussed in Sections 3.1 and 4.1 and Appendix B of the MPR DEIS. The Legacy at Prospector plat has been mapped as Zone 4 “Low Hazard Risk.”

e. Describe the purpose, type, and approximate quantities of any filling or grading proposed. Indicate source of fill.

For The Legacy at Prospector roadway and utility infrastructure construction, the estimated grading quantities are approximately 1,500 cubic yards of cut and approximately 1,200 cubic yards of fill. Cut material will likely be deposited to another project site within the MPR. Materials for utility backfill and road base would be imported from offsite sources.

h. Proposed measures to reduce or control erosion, or other impacts to the earth, if any:

Suncadia, LLC maintains a stormwater pollution prevention plan for the entire MPR that will also be applicable to development of The Legacy at Prospector. An NPDES permit for MPR construction activities has been issued by the Washington State Department of Ecology (Permit No. WA-005236-1). Conditions of the permit specify erosion control measures that will be used during construction activities.

2. AIR

a. What types of emissions to the air would result from the proposal (i.e. dust, automobiles, odors, industrial wood smoke) during construction and when the project is completed? If any, generally describe and give approximate quantities if known.

Air Quality is discussed in Sections 3.5 and 4.5 of the DEIS. During construction, wind-blown dust and emissions from construction equipment could travel off-site. Construction emissions would be minor and short-term. When construction is complete, air emissions would include those typical from automobiles and would be low in volume, corresponding to the small traffic volumes produced by light-density residential use and golf course traffic. Wood-burning stoves and fireplaces will not be permitted in the completed homes.

3. WATER

a. Surface

1) Is there any surface water body on or in the immediate vicinity of the site (including year-round and seasonal streams, saltwater, lakes, ponds, wetlands)? If yes, describe type and provide names. If appropriate, state what streams or river it flows into.

No surface water body is located on the property. Information on surface waters and wetlands throughout the MPR site is provided in Sections 3.4, 4.4, and Appendix F of the DEIS, and Section 3.4 of the FEIS.

4) Will the proposal require surface water withdrawals or diversions? Give general description, purpose, and approximate quantities if known.

The proposed MPR water supply system, including water quantities and water rights transfers, is described in detail in Sections 2.4 and 3.3 and Appendix A of the FEIS and in Sections 3.4 and 3.16 and Appendices B and C of the Cle Elum/UGA FEIS. Surface water diversions to supply the MPR, including The Legacy at Prospector, would be required from the Yakima River (via previously constructed diversion facilities). The Kittitas County Water Conservancy Board and the Washington Department of Ecology have approved the water rights transfer applications needed to allow this diversion.

c. Water Runoff (including storm water):

1) Describe the source of runoff (including storm water) and method of collection and disposal, if any (include quantities, if known). Where will this water flow? Will this water flow into other waters? If so, describe.

Stormwater runoff from roads, buildings, landscaped areas, and open space areas would be controlled through collection in catch basins and pipes or grass lined ditches and conveyed to offsite water quality, detention, and infiltration facilities as described in Part 3 – Stormwater Management Plan of the attached Preliminary Site and Utility Engineering Summary.

d. Proposed measures to reduce or control surface, ground, and runoff water impacts, if any:

Stormwater runoff from roads would be treated for water quality on and offsite using best management practices as outlined by Department of Ecology and the MPR Conditions of Approval sections B-9 through B-16. Proposed methods of stormwater treatment include onsite grass lined ditches and offsite bio-infiltration, biofiltration swales, and/or wetpond treatment.

5. ANIMALS

b. List any threatened or endangered species known to be on or near the site.

Appendix E of the DEIS discuss threatened, endangered, sensitive and other priority wildlife species in detail. These include federal species of concern, and state candidate species, some of which have been found on the MPR site.

Goshawk – Federal Species of Concern

Pileated Woodpecker – State Sensitive Species

Bald Eagles (State and Federal threatened species) occasionally forage along the Cle Elum and Yakima Rivers. No nesting, roosting, or winter concentration areas for bald eagles are located on the MPR site.

Steelhead (*Oncorhynchus mykiss*) and bull trout (*Salvelinus confluentus*) are listed as threatened species under the federal Endangered Species Act and are present near the MPR site. Westlope cutthroat trout (*Onchorhynchus clarki lewisi*) is a federal species of concern found in the area.

d. Proposed measures to preserve or enhance wildlife, if any.

A land stewardship plan has been prepared for the MPR and will be adhered to. The Land Stewardship plan identifies 15 different management zones, including provisions for wildlife enhancement. Section 4.4.3 and Appendix E of the DEIS, Section 3.4.3 of the FEIS, and the Land Stewardship Plan discuss mitigation measures to retain or enhance wildlife habitat.

7. ENVIRONMENTAL HEALTH

a. Are there any environmental health hazards, including exposure to toxic chemicals, risk of fire and explosion, spill, or hazardous waste that could occur as a result of this proposal? If so, describe.

Project construction would include the health and safety hazards typical for residential and infrastructure construction. Hazards after project completion would be typical of those for residential and recreational uses.

1) Describe special emergency services that might be required.

The need for fire protection and emergency response/aid services during MPR construction and operation is discussed in Section 4.13 of the DEIS. The additional fire protection services needed would be provided by local jurisdictions, primarily Fire District No. 7. Emergency medical services would be provided by Fire District No. 7 and the Kittitas County Hospital. No needs for special emergency services would apply to construction or operation of the proposed action.

2) Proposed measures to reduce or control environmental health hazards, if any.

Construction contractors would follow standard safety practices for the applicable types of construction. Furthermore, the Suncadia fire station at 31 Fire House Road (at the northwest intersection of Bullfrog Road) is able to provide quick response to hazards.

b. Noise

2) What types and levels of noise would be created by or associated with the project on a short-term basis (for example: traffic, construction, operation, other)? Indicate what hours noise would come from the site.

Noise impacts and mitigation measures are discussed in Section 4.6 of the DEIS and Sections B-46 through B-50 of the MPR Conditions of Approval.

During construction, temporary increases in sound would occur on area roadways due to haul vehicles transporting construction materials to and from the project site. Typical construction noise would include truck traffic, construction equipment, and building construction. After construction, noise would include those sounds typically associated with a residential community, including traffic, garbage collection, and outdoor recreation use.

3) Proposed measures to reduce or control noise impacts, if any.

During construction, the Kittitas County noise ordinance will be followed, and construction hours will be limited. Construction equipment would utilize properly sized and maintained mufflers, engine intake silencers, and engine enclosures. In addition, idle equipment may be turned off and construction would be limited to daytime hours. In addition, the MPR Conditions of Approval (Sections B-46 through B-50) will be adhered to.

Snowmobile use is limited within the MPR by C-13.

8. LAND AND SHORELINE USE

a. What is the current use of the site and adjacent properties?

The Legacy at Prospector property is undeveloped and located between the Prospector golf course to the northeast, Phase 1 Division 5 property to the south (Prospector 's Reach), and Phase 1 Division 7 (Miner's Camp) to the west.

1. Proposed measures to ensure the proposal is compatible with existing and projected land

uses and plans, if any.

The Legacy at Propsector site is within the MPR site and is consistent with the September 2000 Conceptual Master Plan approved by Kittitas County and the Master Planned Resort development agreement that has been adopted by Kittitas County ordinance, and the Phase 1 General Site Plan as revised on February 16, 2005.

9. HOUSING

c. Proposed measures to reduce or control housing impacts, if any.

Measures to reduce or control housing impacts are required under the MPR Conditions of Approval Sections C-59 through C-61. Under C-60 in particular, the private sector external to the MPR continues to supply adequate housing stock and no further measures or mitigation are required at this time.

10. AESTHETICS

a. What is the tallest height of any proposed structure(s), not including antennas; what is the principal exterior building material(s) proposed?

Residential structures would be a maximum of two stories or up to approximately 50 feet above ground elevation (depending on existing topography). Principal exterior building materials would include wood, metal, concrete and stone for walls. Metal or composition shingles would be used for roofing material.

b. What views in the immediate vicinity would be altered or obstructed?

Visual impacts and mitigation measures are discussed in Section 4.11 of the DEIS. The forested setting would change to a developed landscape, which would be suburban in character. The developed areas would include views of vegetation intermixed with roadways, building rooftops and facades, vehicles and maintained landscape and lawn areas. There would likely be occasions in the vicinity of the MPR where viewing position and topography would allow limited views of development. No significant views would be obstructed, and the degree of change evident in these views would not be large.

c. Proposed measures to reduce or control aesthetic impacts, if any.

Suncadia has adopted and is implementing architectural design guidelines and requirements to reduce or control aesthetic impacts. Typical mitigation measures for aesthetic impacts would include retention of vegetation for buffers and screening, and use of unobtrusive building materials with natural colors and textures. A design review committee will review architectural design of all proposed structures. Sensitive site design and the use of natural materials would be encouraged. Retention of vegetation within and around the proposed development would reduce the extent of development visible from distant viewpoints. The guidelines set forth in the MPR Conditions of Approval, Sections C-21 through C-23, will be adhered to.

11. LIGHT AND GLARE

a. What type of light or glare will the proposal produce? What time of day would it mainly occur?

Section 3.11, Section 4.11, Appendix I of the DEIS, and Section 3.11 of the FEIS include discussions of light and glare issues. As discussed in the EIS, roads and structures within The Legacy at Prospector would have minimal nighttime lighting. Typical levels of light associated with residential development would be the prominent light sources. Vehicle headlights on roads would contribute to light emissions. Increased traffic would contribute to off-site light and glare.

d. Proposed measures to reduce or control light and glare impacts, if any.

Use of natural construction materials, non-reflecting surfaces, and vegetative buffers would reduce or control light and glare impacts. Residential lighting would be reduced or controlled through implementation of MPR Codes Covenants and Restrictions, and architectural design guidelines that specify down-lighting and shaded fixtures for exterior lighting. In addition, a “dark sky” lighting plan will be implemented to reduce glare from common areas (streets, parking areas, etc). These requirements are consistent with the MPR Conditions of Approval, C-24 through C-26.

12. RECREATION

a. What designated and informal recreational opportunities are in the immediate vicinity?

Section 3.12 of the DEIS documents existing recreational opportunities in the area of the MPR. Current or recent recreational uses on or adjacent to the site, such as golf courses, an extensive trail system, swimming facilities, an ice rink, and Bautista and Dawson Park have been limited to selected types of low-intensity, informal recreation, including hiking, horse riding, fishing, golf, swimming, and ice skating. Snowmobiling through the MPR property is not allowed except as strictly limited by the CC&R’s consistent with the County Conditions of Approval.

13. HISTORIC AND CULTURAL PRESERVATION

b. Generally describe any landmarks or evidence of historic, archaeological, scientific, or cultural importance known to be on or next to the site.

There are no known archeological sites on or in the immediate vicinity of the project site. Section 4.10 and Appendix H of the DEIS and 3.10 of the FEIS discuss potential impacts and mitigation measures for discovery and preservation of cultural resources. The Draft EIS also identifies 101 known cultural resources on the MPR site. Most of the cultural resources on the MPR property are historic sites; primarily refuse scatters, mining-related features, and waterlines with associated features. Prehistoric sites, which account for approximately one-third of the cultural properties on the MPR, are typically lithic scatters (flakes and fragments from stone tool-making activity) or isolated finds.

14. TRANSPORTATION

f. How many vehicular trips per day would be generated by the completed project? If known, indicate when peak volumes would occur.

Traffic impacts of the MPR, including The Legacy at Prospector, are identified in the Sections 3.9 and 4.9 of the DEIS and Appendix D of the FEIS. Based on the analysis parameters applied for the EIS and the number of units in this development, the completed (full-buildout) residential portion of the proposed action is less than what was assumed for the EIS analysis.

Signature

The above answers are true and complete to the best of my knowledge. I understand that the lead agency is relying on them to make its decision.

Signature of Land Owner of Record (required for application submittal):

NEW SUNCADIA, LLC,
A Delaware Limited Liability Company

By: Suncadia Operating Member, LLC,
A Delaware Limited Liability Company,
Its: Managing Member

By: LDD Suncadia Manager, Inc.,
A Delaware Corporation
Its: Manager

By: 
Its: ~~SECTOR~~ VICE PRESIDENT

2/22/17
Date

By: 
Its: GARY A. KITTLESON
VICE PRESIDENT

2/22/17
Date



SUNCADIA
RESORT · COMMUNITY · LEGACY

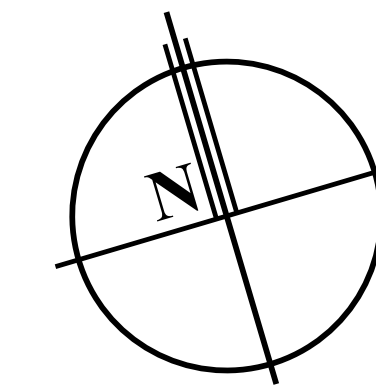

SCALE: 1" = 60'

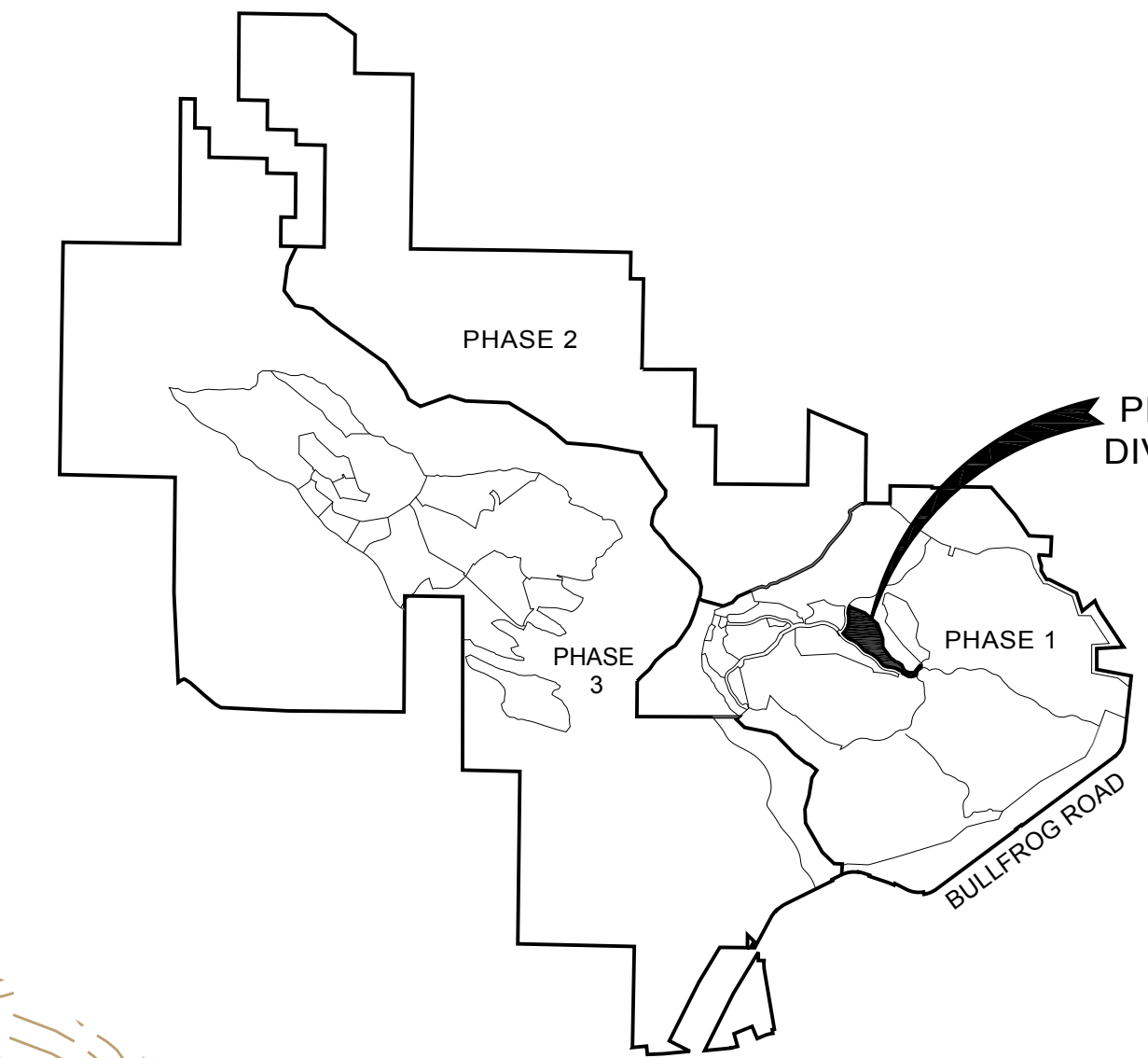

SUNCADIA MPR
LOCATION MAP
NOT TO SCALE

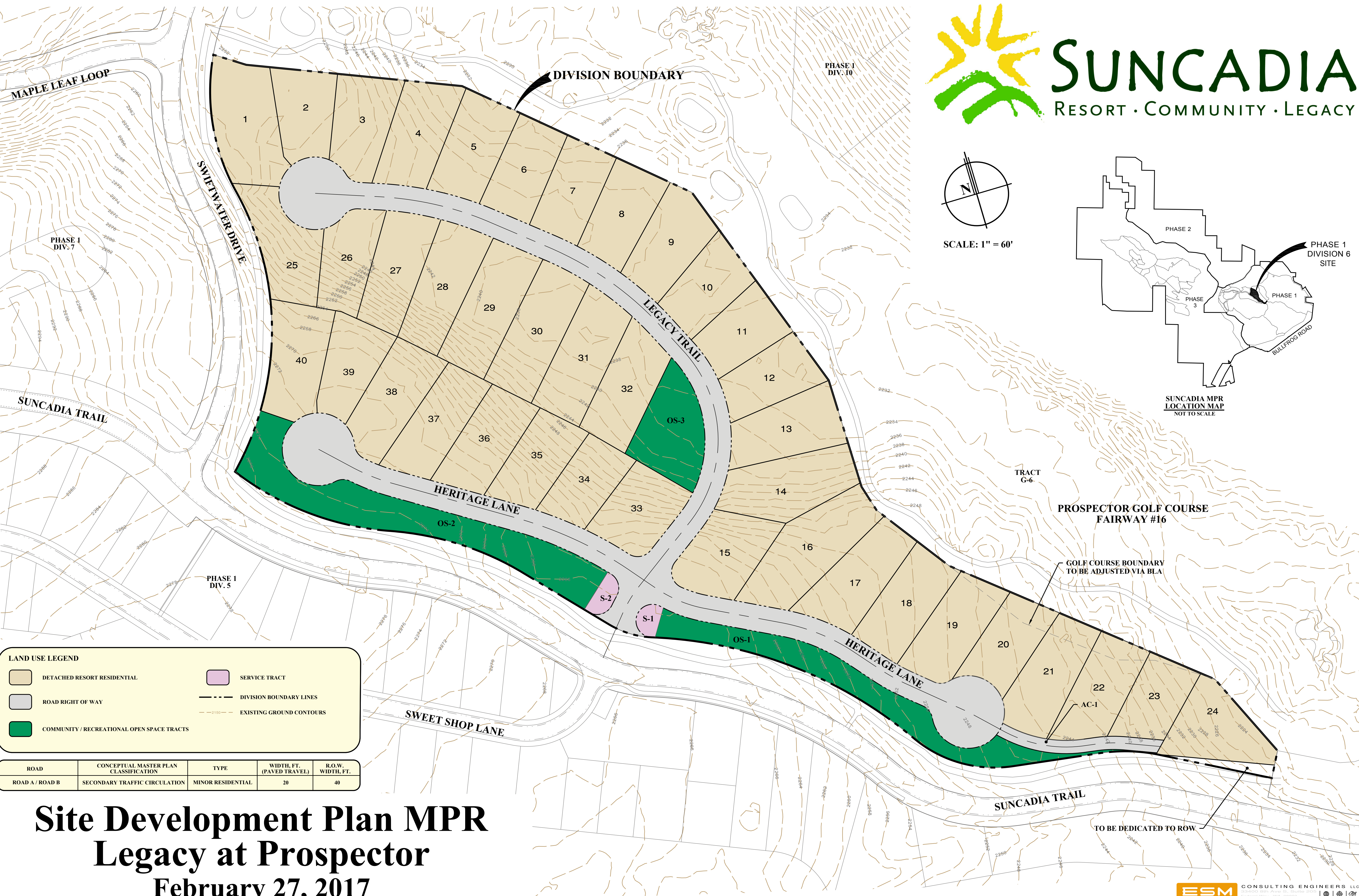

LAND USE LEGEND

	DETACHED RESORT RESIDENTIAL		SERVICE TRACT
	ROAD RIGHT OF WAY		DIVISION BOUNDARY LINES
	COMMUNITY / RECREATIONAL OPEN SPACE TRACTS		EXISTING GROUND CONTOURS

ROAD	CONCEPTUAL MASTER PLAN CLASSIFICATION	TYPE	WIDTH, FT. (PAVED TRAVEL)	R.O.W. WIDTH, FT.
ROAD A / ROAD B	SECONDARY TRAFFIC CIRCULATION	MINOR RESIDENTIAL	20	40

Site Development Plan MPR
Legacy at Prospector
February 27, 2017

PROSPECTOR GOLF COURSE
FAIRWAY #16

GOLF COURSE BOUNDARY
TO BE ADJUSTED VIA BLA

TO BE DEDICATED TO ROW

Site Development Plan for Suncadia The Legacy at Prospector

Information required by Section 5.1(h) of the Development Agreement for The Legacy at Prospector (Phase 1 Division 6) Site Development Plan is provided as shown below.

A proposed Site Development Plan for the Suncadia project, or Phase or Subphase thereof, shall include the following:

(1) **A vicinity map showing the location of the Resort area encompassed within such plan.**

A Site Development Plan (SDP) for The Legacy at Prospector is provided herein. A vicinity map is included on the SDP as required. See the full size SDP Exhibit included in this report.

(2) **A map of the applicable site drawn to an appropriate scale depicting the following:**

- (i) *Arrangement of land uses by type (Master Planned Resort Accommodation Units, including Short-Term Visitor Accommodation Units, Visitor-Oriented Amenities, Developed On-Site Recreational Facilities, Open Space and other Permitted Uses), including descriptions of land use and approximate percentage of land in each use category.*

The Legacy at Prospector construction consists of 40 detached residential lots (primarily second or vacation homes), and open space.

- (ii) *Boundaries and lot lines for all parcels and lots.*

Refer to the Site Development Plan Exhibit for boundary configuration of The Legacy at Prospector and the location of its improvements.

- (iii) *Elevation contours at intervals drawn to an appropriate scale for the Resort area encompassed within the plan.*

Refer to the Site Development Plan Exhibit for elevation contours.

- (iv) *Names and dimensions of public roads bounding or near the site.*

See the Vicinity Map on the Site Development Plan exhibit for this information. The primary access to the site will be provided from Suncadia Trail and Swiftwater Drive also borders the plat along the west side.

- (v) *Preliminary engineering plans, including site grading, road improvements, drainage and public utility extensions.*

Refer to the Preliminary Site and Utility Engineering Summary of this document for preliminary planning for road improvements, drainage and public utility extensions. Site grading will be associated with roadways and development of the parcel. Roadways follow natural grades to the extent possible as an element of the site design. This design object will minimize the amount of earthwork involved in road construction.

(vi) ***Location of all buildings identified by type of use.***

Refer to the Site Development Plan Exhibit.

(vii) ***Location and number of off-street parking areas, including type of surfacing; and the approximate number of spaces to be provided.***

Each residence in the division would include dedicated on-site parking that would vary per individual residence.

(viii) ***The location, type and dimensions, and names of roads and driveways.***

The location and names of roads are shown on the Site Development Plan Exhibit. Dimensions of roads are given in the Preliminary Site and Utility Engineering Summary Part 2.

(ix) ***The location, type and dimensions, of Developed On-Site Recreational Facilities.***

Refer to the Site Development Plan exhibit and section (4), below.

(x) ***The locations and calculations of the total area of Open Space and percentages.***

Locations of open space areas are shown on the Site Development Plan exhibit, and are quantified on Exhibit M, included with this Application.

(xi) ***Proposed location of fire protection facilities.***

Refer to the Conceptual Utility Plan Exhibit for fire hydrant locations. The water system for the site will connect to the water mains in Suncadia Trail and Swiftwater Drive. The development will be served by the Suncadia Water Company, a Class A water system regulated by the Department of Health. The Suncadia Water Company has included this parcel in their comprehensive planning. The Resort is served by Fire District 7. A fire station for District 7 is located on the Resort at 31 Firehouse Road, at the northwest intersection of Bullfrog Road.

(3) A statement describing the development plan in relationship to adjacent development and natural features.

The Legacy at Prospector project site slopes generally to the northeast to the existing Prospector golf course. The Prospector golf course borders the north side of the project, Suncadia Trail is on the south side, and Swiftwater Drive is on the west side.

(4) A description of the Master Planned Resort Accommodation Units (including Short-Term Visitor Accommodation Units), Visitor-Oriented Amenities, developed On-Site Recreational Facilities, Open Space and other Permitted Uses proposed by Trendwest for the Resort area encompassed within the Site Development Plan.

This Site Development Plan includes the following elements (defined terms from the Development Agreement in parentheses):

- a) 40 Vacation Homesites and Associated Roadways
- b) Community/Recreational Open Space (Open Space)

The Legacy at Prospector plat Vacation Homesites consist of detached resort residential lots that range from 10,500 to 17,500 square feet. A vacation or second home at Suncadia is considered a Short Term Accommodation Unit unless its owner(s), or any one of them, is either (i) registered to vote at such unit's Suncadia address or (ii) receives its/their Kittitas County annual property tax assessment at such unit's Suncadia address, in which case such unit shall be considered a permanent residence.

(5) A description of plans for landscaping (including tree planting) and restoring natural areas affected by construction and plans for the preservation of Open Space.

Since this Site Development Plan is consistent with the approved LSP and Phase 1A, Addendum an amendment specific to this plan has not been submitted. The following activities, which are discussed in more detail below, will implement the approved Land Stewardship Plan and Noxious Weed Control Supplement.

- 1) Road edges
- 2) Areas around the homes

Road edges and drainage ditches

These disturbances will appear in the form of cut and fill banks. Generally, the approach to their restoration will be by hydro seeding of an approved mix, with an optional application of wildflower overseed. Where disturbances are identified as falling within specifically targeted wildlife habitats, restoration will include compatible species as listed in the Land Stewardship Plan.

In all cases, the recommendations of the Noxious Weed Control Supplement to the Land Stewardship Plan will be implemented.

Unirrigated sites

Where landscapes are installed (including hydro seeded areas) “establishment” watering will occur as necessary to reestablish the area.

Open Space

Open space areas are identified on the Site Development Plan. Largely, these areas will be left in their natural form. In some cases, compatible species will be planted in open space areas to provide additional screening. A Land Stewardship Plan will be developed to ensure the long term health of the open space area.

Irrigated areas around the Homesites

Irrigation is allowed on a limited basis under the CC&Rs, and the use of natural vegetation will be emphasized.

(6) Provisions to ensure permanence and maintenance of Open Space

The property consists of two community/recreation open space tracts which will be owned and maintained as provided by the CC&Rs.

A form (Exhibit M) summarizing the open space is also included with this application.

(7) A description outlining future land ownership patterns within the development, including any planned homeowners’ associations, and proposed CC&R’s if any.

Suncadia in this plat is or will be governed by extensive covenants, conditions, and restrictions on community, residential, and commercial activities, all of which are or will be filed of record.

(8) Proposed plans for: (i) water supply, including demand and supply assumptions and methodologies used to develop such plan; (ii) water supply storage and distribution systems; (iii) sewage collection, treatment and disposal; (iv) surface water management; and (v) solid waste management.

Refer to the Preliminary Site and Utility Engineering Summary in the application document for a description and illustration of the proposed utility infrastructure.

(9) A staging plan describing the timing or sequence of construction for all the elements of the Site Development Plan, including Developed On-Site Recreational Facilities and Visitor-Oriented Amenities.

The anticipated timing of construction of the Site Development Plan elements is outlined below.

Element	Schedule
Utilities	2 nd , 3 rd Quarters 2017
Roadways	2 nd , 3 rd Quarters 2017
Homes	2018 – 2020

(10) Results of monitoring as required by the MountainStar MPR Conditions and Section 4.1(g)(4) above as of the date of submittal of the Site Development Plan.

Monitoring reports as required by the MountainStar MPR Conditions, specifically Section E-1(a), and Section 4.1(g)(4) of the Development Agreement are on-going and are to be reviewed prior to or concurrent with SDP approval and final consistency review.

(11) A statement identifying any deviation(s) between such plan and the MountainStar Resort Conceptual Master Plan or, alternatively, and if applicable, an approved General Site Plan.

There are no deviations between The Legacy at Prospector Site Development Plan and the Phase 1 General Site Plan revised February 16, 2005.

(12) Any appropriate environmental documentation.

Environmental documentation for this Site Development Plan is provided by the SEPA checklist submitted concurrent with this SDP. No additional environmental review is required.



SUNCADIA
RESORT · COMMUNITY · LEGACY

***Preliminary Site and Utility
Engineering Summary***

**The Legacy at Prospector
(Phase 1 Division 6)
Site Development Plan**

**Suncadia
Master Planned Resort**

**New Suncadia, L.L.C.
Cle Elum, Washington**

February 27, 2017

Prepared by

**ESM Consulting Engineers, LLC
33400 8th Avenue South, Suite 205
Federal Way, WA 98003**

**253.838.6113 tel
253.838.7104 fax**



www.esmcivil.com

Information presented in this document pertains to the proposed roads, illumination, drainage, water and sewer facilities, and solid waste management program to serve The Legacy at Prospector (Phase 1 Division 6) plat.

Information on the proposed roads reflects the requirements of Exhibit J to the Development Agreement. Information on storm drainage reflects the requirements of the Department of Ecology Stormwater Management Manuals, the 1999 Master Drainage Plan and preliminary stormwater engineering for Phase 1.

Information on the proposed water supply, storage and distribution system, is taken from the June 2001 MPR Water System Plan and the July 2002 Reservoir, Pumping and Transmission Design Reports that were approved by the Washington State Department of Health and preliminary water system engineering performed for Phase 1. The water demands presented in this report reflect a lower density within the resort than the demands presented in the approved WSP. The WSP was amended in 2004 to reflect these changes. The development will be served by the Suncadia Water Company, a Class A water system regulated by the Department of Health.

Information on the proposed sewage collection, treatment and disposal system is taken from preliminary engineering for Phase 1 and the March 2000 Site Engineering Technical Summary document for the MPR (Appendix A of the FEIS).

Discussed in this part are the classification of The Legacy at Prospector (Phase 1 Division 6) roads, proposed road sections, roadway illumination and emergency access.

Roadway Classifications

The Legacy at Prospector roads shown in the Site Development Plan are classified as follows:

Road	Conceptual Master Plan Classification
Road A	Secondary Traffic Circulation
Road B	Secondary Traffic Circulation

Roadway Sections

The proposed roadway section for the project is shown in Figure 2-1. Applicability of the sections is as follows:

Road	Type	Figure
Road A	R-II - Minor Residential – Two-Way	2-1
Road B	R-II - Minor Residential – Two-Way Alternative #2	2-1

Access

PRIMARY ACCESS: As illustrated on the General Site Plan, primary access to the project site from Bullfrog Road will be provided via Suncadia Trail. Suncadia Trail ties into Bullfrog Road southwest of Roslyn.

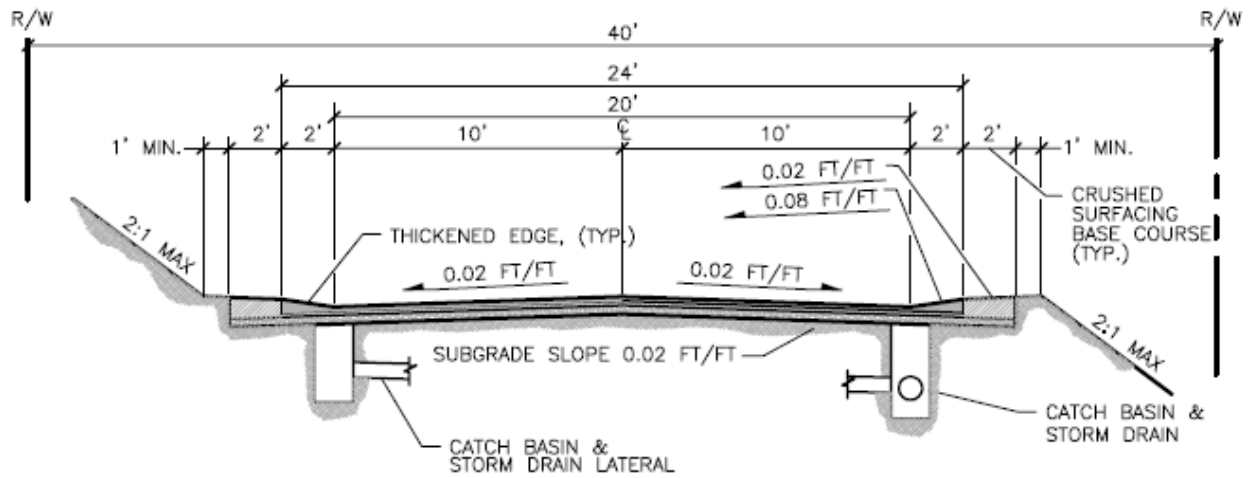

TYPE R-II
MINOR RESIDENTIAL ROADWAY
 NOT TO SCALE

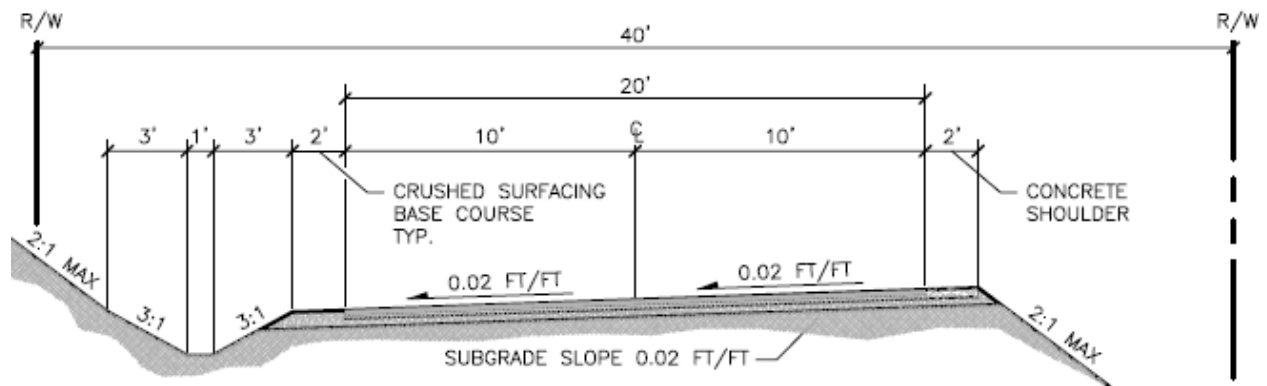

TYPE R-II
MINOR RESIDENTIAL ALT #2 ROADWAY
 NOT TO SCALE

Figure 2-1

Illumination

Street lighting designs will conform to the principals of preserving dark skies while providing lighting levels appropriate for roadway safety and security. Street lighting will conform to the following planning criteria.

- a) Use of full-cutoff shielding on outdoor light fixtures;
- b) Mounting of light fixture luminaries at a height of not greater than 30 feet;
- c) Establishment of roadway lighting standards based on needed light distribution and the luminance of roadway surfaces;
- d) Use of LED street lights;
- e) Use of timer or photo-cell controls to regulate when and where lighting would occur; and
- f) Avoiding unnecessary lighting of building facades.

Streetlights will be located at intersections, pedestrian trail crossings, and other locations where needed. Alternative luminary styles will be considered during project design.

Introduction

The preliminary Stormwater Management Plan for The Legacy at Prospector (Phase 1 Division 6) of the Suncadia Master Planned Resort (MPR) is described in this part. The Stormwater Management Plan reflects application of design guidelines detailed in the Department of Ecology Stormwater Management Manuals as well as information presented in the April 1999 (Rev. July 1999) Master Drainage Plan (MDP) that was prepared by W&H Pacific for the MPR. The MDP outlines stormwater design procedures, guidelines, and protocols for the development.

Updates to the MDP include;

- (1) adoption of the drainage standards set forth in Washington State Department of Ecology's Stormwater Management Manual for Western Washington August 2001 (DOE SMM),
- (2) an addendum to the MDP dated August 2002 that provides (a) water quality protocol information for golf course areas that discharge to surface waters, and (b) revision of golf course water quality protocol summary information for infiltration to conform with the detailed protocol information.

Design specifics addressed in this part include:

- Runoff rate/volume estimation methodology
- Infiltration facility collection and conveyance
- Water quality treatment
- Overflow routing
- Conceptual Stormwater Plan

The proposed land use for the resort is shown in the General Site Plan for Phase 1. The Legacy at Prospector is located north of Suncadia Trail, south of the Prospector golf course and east of Swiftwater Drive. The Suncadia stormwater system will be owned, operated, and maintained by either the Suncadia Residential Owners Association, or the Suncadia Community Council, depending on the location within the resort. Construction of facilities will be by Suncadia, L.L.C..

Conceptual Drainage Plan

Stormwater runoff for The Legacy at Prospector roadways will be divided into two separate local basins, then conveyed downstream, following the natural topography of the site, to the existing regional facility in the Prospector golf course (water feature located southeast of the Suncadia Trail roundabout) where it will be treated for water quality and detained for flow control.

The majority of the project area has a soil classification of Qgm which consists of glacial moraine deposits – till soils. A small remaining southeast portion of the project area has a soil classification of Qow which consists of glacial outwash deposits – outwash soils. For additional information regarding the existing geology and soils information, see the EIS Technical Report for Geology, Groundwater and Soils prepared by AESI and dated June 29, 1999.

Runoff from Road A will be collected in catch basins, conveyed in pipes to the existing Prospector golf course to the north and be dispersed in two 50 foot wide gravel dispersion trenches and be incorporated within the golf course drainage system.

Runoff from Road B will be collected and treated for water quality in a grass-lined swale along the south side of the road and be connected to the existing southeast storm drainage system in Suncadia Trail.

Runoff from the 40 detached resort residential units will be typically handled on the individual lots by dispersion and infiltration.

In summary, stormwater runoff from The Legacy at Prospector will be directed via different routes to the existing regional facility in the Prospector golf course which has been sized to include this development.

Infiltration and Detention Facilities

As discussed above in the Conceptual Drainage Plan narrative, infiltration may be provided for individual lots and no detention facilities are proposed on site. The proposed project will be directed to flow to the natural downstream location – the existing Prospector golf course water quality and detention facility that has been sized to accommodate this development.

Water Quality Treatment

Water quality treatment will be provided for runoff from impervious road surfaces requiring stormwater treatment. Treatment will be provided in one of several Department of Ecology recommended treatment facility types. Water quality treatment options available for Suncadia are wetponds/lakes, stormfilter systems, biofiltration swales, bio-infiltration and sheet flow dispersion. All water quality facilities are sized to treat the water quality storm. The water quality storm is that storm for which all storms equal or smaller in size account for 90 percent of the average annual runoff. For Phase 1, the water quality design storm is 1.68 inches in 24-hours. Proposed water quality facilities are described below.

Sheet Flow Dispersion

Sheet flow dispersion is an approved Department of Ecology water quality and quantity control method for areas that preserve the existing forest duff. D.O.E. allows this treatment when the impervious area is less than 10 percent of the basin and 65 percent or more of the forest duff is retained.

This water quality treatment method will be used for a portion of Road A and for flow control for the 40 detached resort residential units.

Biofiltration Swales

Biofiltration swales are another approved DOE water quality treatment facility. This facility is also designed to treat the water quality storm. The design criterion for a biofiltration swale is residence time in the swale. For a given flow rate, the required residence time is a duration equal to that which would be provided by a 200 ft long swale, flow depth of 4 inches, and maximum velocity of 1.5 feet-per-second, or about two and one-half minutes.

For The Legacy at Prospector, the biofiltration (grass-lined) swale will be located on the south side of Road B.

Biofiltration swales on the Suncadia project will not be irrigated and, therefore, must be seeded with drought resistant vegetation suitable for the upper Kittitas County climate. The typical seed mixture used for the Suncadia biofiltration swales is as follows:

Seed Mixture Type	Percentage
Sherman Big Blue Grass	10
Joseph Idaho Fescue	30
Sodar Streambank Bunch Grass	30
Secar Blue Bunch Wheat Grass	30

(Source: Wildland, Inc., Richland, WA, October 2000.)

This mixture may be changed to accommodate site conditions or recommendations from design professionals and will be hydroseeded at the

application rate of 60 pounds seed mixture per acre. Additionally, a tacifier will be used to prep the soil before application of the hydroseed mixture.

Wetponds

Wetponds contain a permanent pool of water to provide the sedimentation and treatment of conventional stormwater pollutants. The DOE SMM specifies that the permanent pool of stormwater shall be equal to the runoff volume of the water quality storm.

The existing Prospector golf course water feature has been sized to accommodate this development.

Overflow Routes

The existing regional facility in the Prospector golf course has been designed with an overflow that discharges further southeast, downstream, to the next golf course water feature.

Source of Water Supply

The development will be served by the Suncadia Water Company, a Class A water system regulated by the Department of Health. The Suncadia Water Company has included this parcel in their comprehensive planning and will provide a water availability letter.

The Legacy at Prospector Water System Description

The preliminary transmission and distribution system for the project site is illustrated on the enclosed Conceptual Utility Plan. The water for the development will be supplied by the MPR water reservoirs. The reservoirs are located in the northeast section of the MPR.

The project site will require a looped 8-inch diameter main that will connect to the water main in Suncadia Trail and Swiftwater Drive. All homes are to be fire sprinklered on site. Hydrants will be placed at a maximum of 500 feet spacing. Fire flow calculations were developed using a flow of 1500 gallons per minute at 20 pounds per square inch (psi) pressure. The Resort is served by Fire District 7. A fire station for District 7 is located on the Resort at 31 Firehouse Road, at the northwest intersection of Bullfrog Road.

General Description

The Legacy at Prospector project consists of 40 detached resort residential vacation homes spaced on 16.8 acres. The collected raw wastewater from developed portions of the site will be conveyed by means of on-site gravity sewer to the existing sanitary sewer system in Suncadia Trail and by on-site gravity and force main sewer to the existing sanitary sewer system in Swiftwater Drive. Wastewater will further continue to off-site gravity sewers to the Waste Water Treatment Plant (WWTP) in Cle Elum.

Suncadia Solid Waste Management Policy

Solid Waste Management is currently being performed per the Solid Waste Management Plan dated April 13, 2006.

Exhibit M
Open Space Calculation
Suncadia Master Planned Resort
February 27, 2017

Phase, Sub-Phase or Plat Name/Number: Phase 1 Division 6

Land Use	A This Plat	B Prior Plats to Date*	C Subtotal This plat and prior plats (A+B)	D Estimated Future Plats	E Estimated Total Project (C+D)
Developed Areas	Acres	Acres	Acres	Acres	Acres
Single Family Lots (1)	6.2	289.8	296.0	516.0	812.0
Multifamily Units (2)	0.0	0.0	0.0	37.0	37.0
Lodge/Commercial/Other (3)	0.0	34.2	34.2	0.8	35.0
Future Development Tracts	0.0	88.0	88.0	-88.0	0.0
Recreation Facilities (3)	0.0	6.1	6.1	23.9	30.0
Roads (4)	1.7	104.6	106.3	60.7	167.0
Total Developed Area	7.9	522.7	530.6	550.4	1081.0
Open Space Areas	Acres	Acres	Acres	Acres	Acres
Private Open Space (5)	6.6	384.6	391.2	168.8	560.0
Future Development Tracts	0.0	737.5	737.5	-737.5	0.0
Access Tracts	0.0	3.3	3.3	6.7	10.0
Vegetated ROW Area	0.9	87.6	88.5	45.5	134.0
Community/Recreation	1.4	183.0	184.4	237.6	422.0
Golf Course	0.0	654.0	654.0	-200.0	454.0
Natural Open Space/Cle Elum River	0.0	276.0	276.0	797.0	1073.0
Natural Open Space/Stream C Corridor	0.0	0.0	0.0	226.0	226.0
Other Natural Open Space	0.0	281.9	281.9	357.1	639.0
Managed Open Space/Easton Ridge	0.0	20.6	20.6	1340.4	1361.0
Perimeter Buffer	0.0	198.9	198.9	161.1	360.0
Total Open Space	8.9	2827.4	2836.3	2402.7	5239.0
Total Plat Area	16.8	3350.0	3366.8	2953.2	6320.0
Open Space Percentage	53.0%	84.4%	84.2%	81.4%	82.9%

- (1) Includes area within Developable Envelope and access drive.
- (2) Includes buildings and parking areas.
- (3) Includes buildings, parking areas, and paved pedestrian areas.
- (4) Includes paved road surface and shoulders.
- (5) Includes open space easements on single family lots and multifamily lots

*Prior plats included in total:

- Phase 1-Division 1
- Phase 1-Division 2
- Phase 3 Divisions 1-5
- Phase 1-Division 3
- Phase 3 Divisions 1-5 Adjustment for Phase 3 Divisions 6-9
- Phase 3 Divisions 6-9
- Phase 1 Division 8 SDP Land Use (not a plat)
- Phase 2 Division 2
- Phase 3 Divisions 1-5 Adjustment for Phase 3 Division 11
- Phase 1 Division 5
- Phase 1 Division 4
- Phase 3 Division 11 Adjustment to remove Preliminary Plat areas from the cumulative totals
- Phase 3 Division 11 (Final Plat total areas)
- Phase 3 Division 11 adjustment for Phase 3 Division 12 to remove Tract Z-1 areas
- Phase 3 Division 12
- Phase 1 Division 10
- Phase 1 Division 3 adjusted for Z1 (Phase 1 Division 10)
- Phase 1 Division 9
- Phase 1 Division 9 adjusted for Z3 (Phase 1 Division 13)
- Phase 1 Division 13B
- Phase 1 Division 7 (Miner's camp)

File: \\Esmc\eng\A\ESM-005\1634\001\009\umbria\EN-05.dwg
 Plot Date: 2/22/2017 10:24 AM

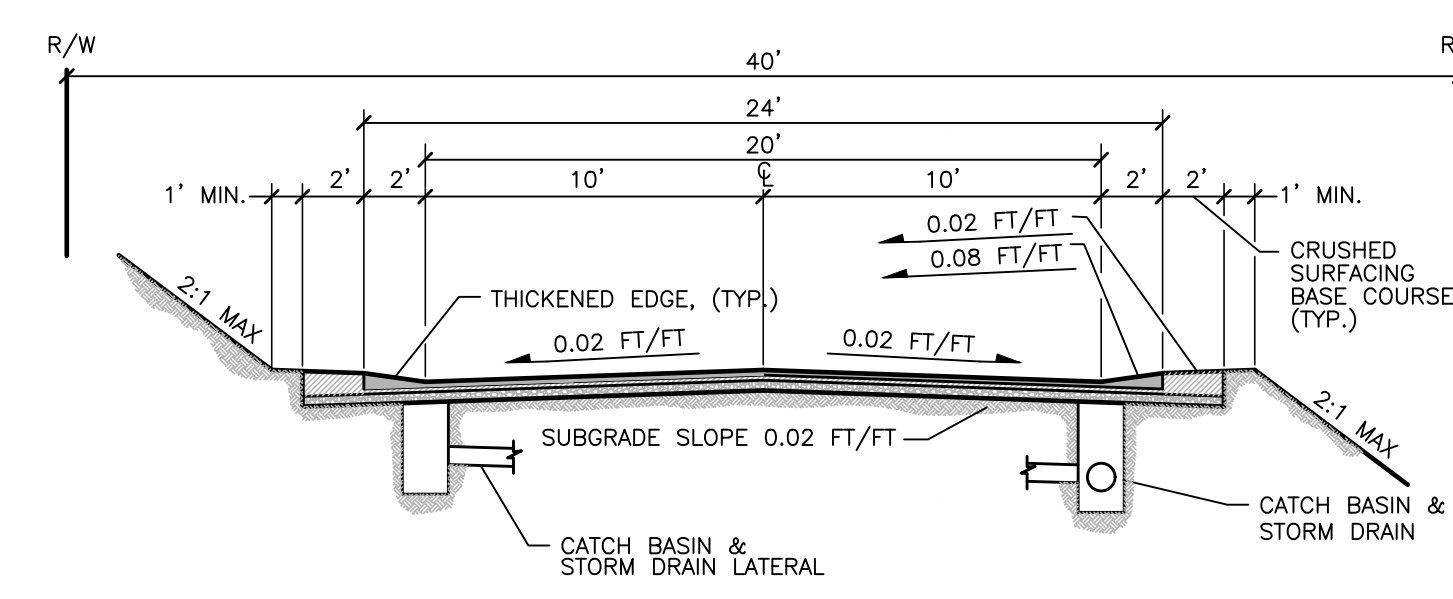
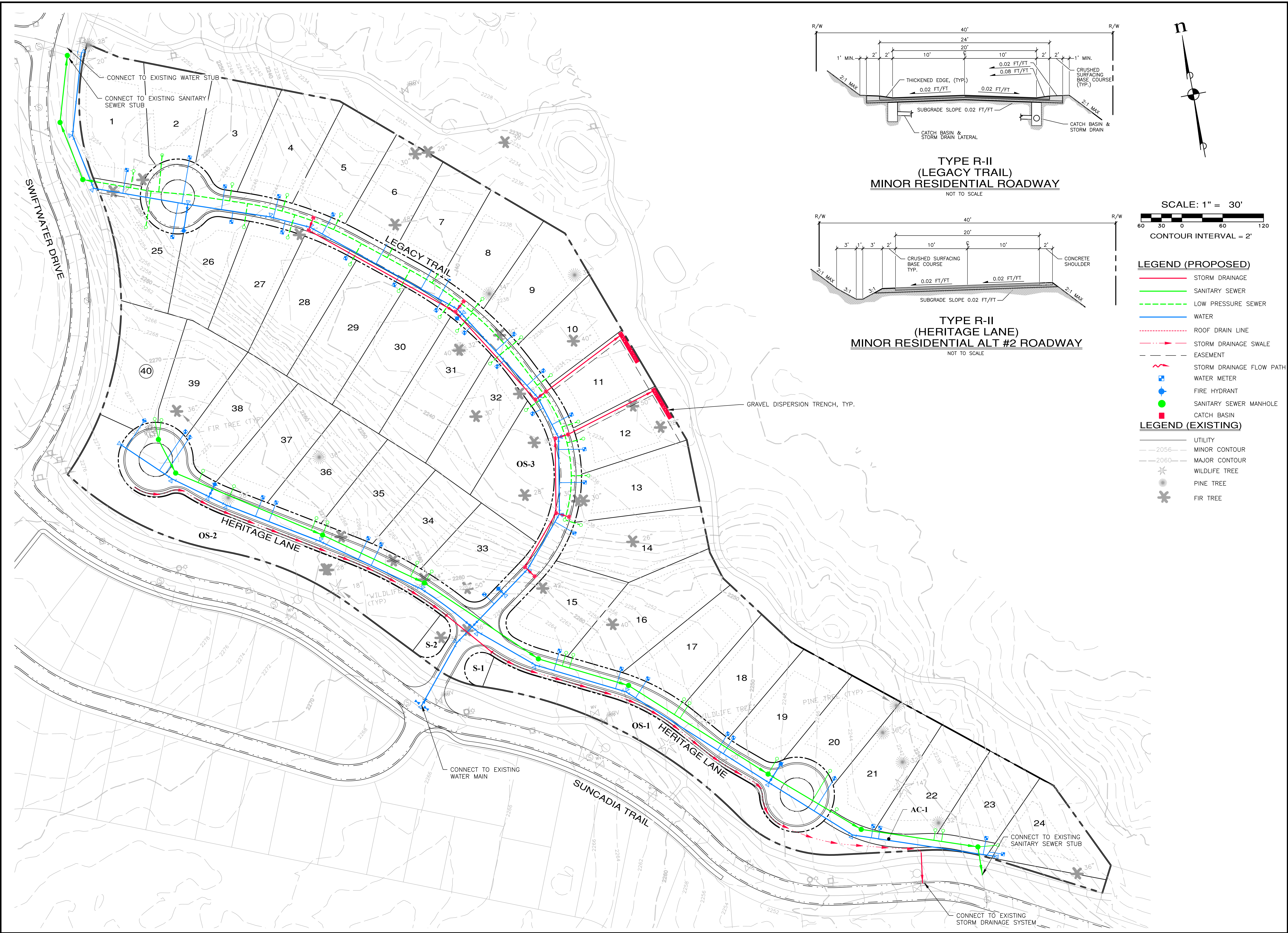

**TYPE R-II
 (LEGACY TRAIL)
 MINOR RESIDENTIAL ROADWAY**
 NOT TO SCALE

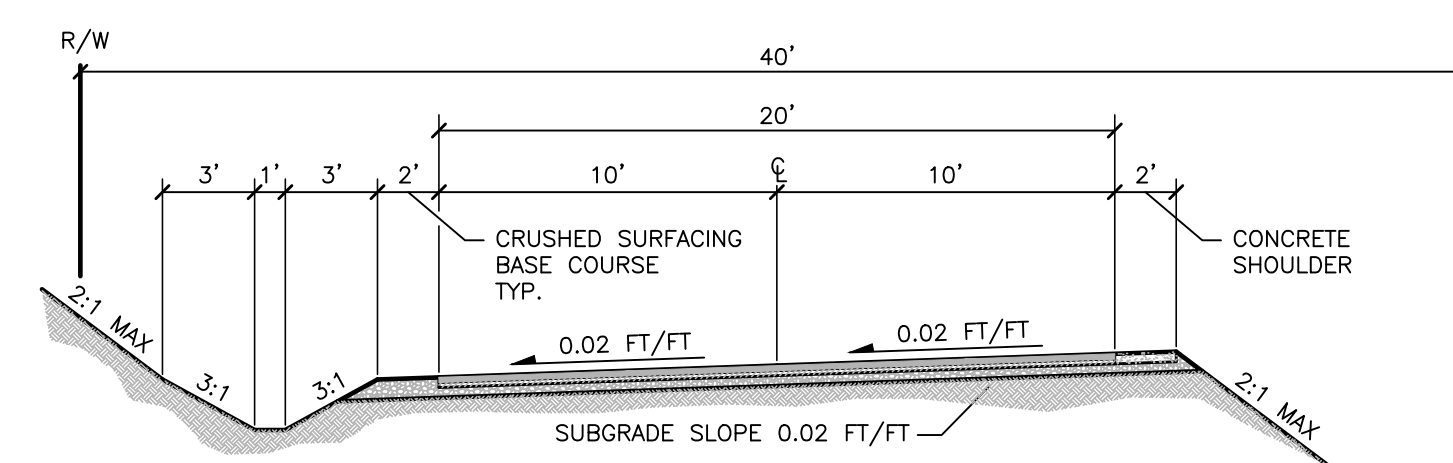

**TYPE R-II
 (HERITAGE LANE)
 MINOR RESIDENTIAL ALT #2 ROADWAY**
 NOT TO SCALE

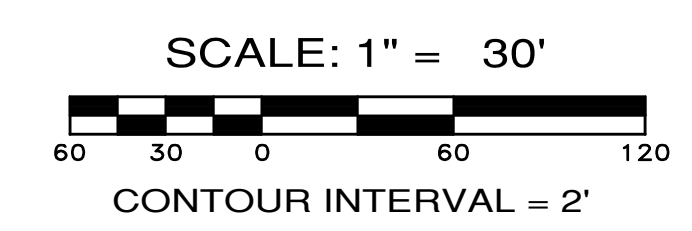

- LEGEND (PROPOSED)**
- STORM DRAINAGE
 - SANITARY SEWER
 - LOW PRESSURE SEWER
 - WATER
 - - - ROOF DRAIN LINE
 - STORM DRAINAGE SWALE
 - - - EASEMENT
 - STORM DRAINAGE FLOW PATH
 - WATER METER
 - FIRE HYDRANT
 - SANITARY SEWER MANHOLE
 - CATCH BASIN
- LEGEND (EXISTING)**
- UTILITY
 - 2056 MINOR CONTOUR
 - 2060 MAJOR CONTOUR
 - * WILDLIFE TREE
 - * PINE TREE
 - * FIR TREE

REVISIONS			
NO.	DESCRIPTION/DATE	BY	

ESM CONSULTING ENGINEERS, LLC
 33400 8th Ave S, Suite 205
 Federal Way, WA 98003

www.esmcivil.com

Civil Engineering
 Public Works

Land Surveying
 Project Management

Land Planning
 Landscape Architecture

NEW SUNCADIA LLC

LEGACY AT PROSPECTOR

COMPOSITE UTILITY PLAN

KITITAS COUNTY WASHINGTON

JOB NO.: 1634-001-009
 DWG. NAME: EN-05
 DESIGNED BY: LGB
 DRAWN BY: JHH
 CHECKED BY:
 DATE: 02/27/2017
 DATE OF PRINT:

EN-05

1 of 1 SHEETS

A PORTION OF SECTIONS 19 & 20, TWP. 20 N., RGE., 15 E., W.M.,
KITITAS COUNTY, WASHINGTON

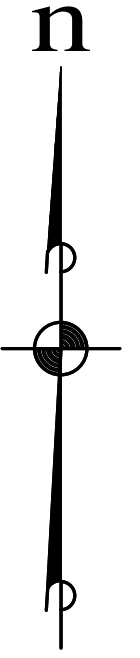
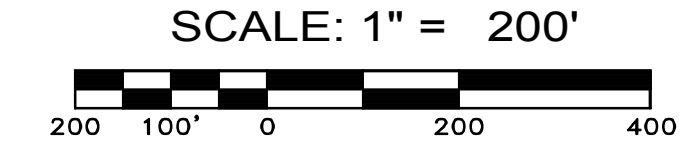

TRACT LEGEND

- OS OPEN SPACE
- S SERVICE
- AC ACCESS TRACT

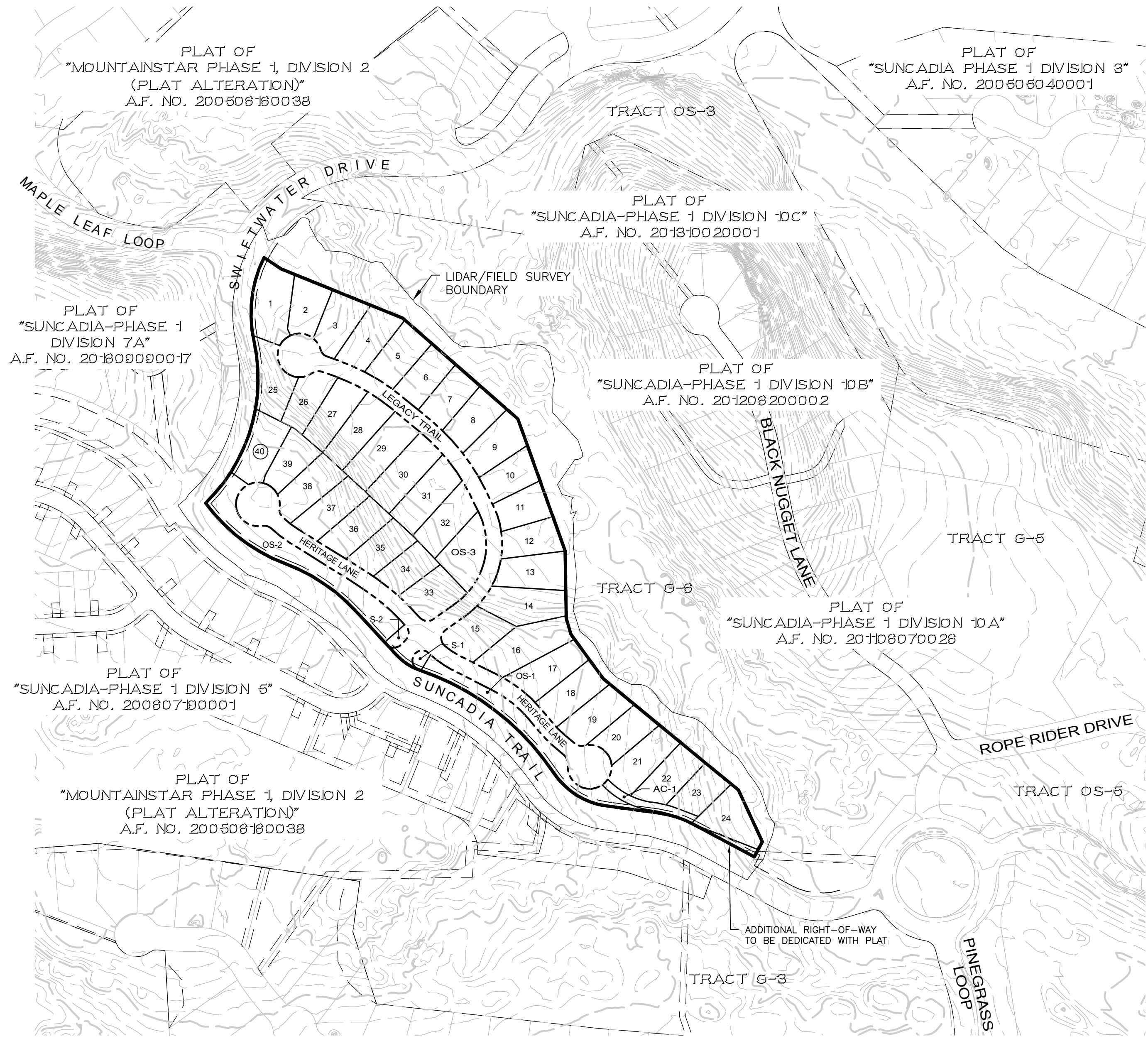

LOT AREA TABLE	
LOT #	AREA (AC)
1	0.40
2	0.26
3	0.30
4	0.32
5	0.31
6	0.28
7	0.27
8	0.29
9	0.31
10	0.27
11	0.25
12	0.27
13	0.33
14	0.38
15	0.33
16	0.44
17	0.34
18	0.32
19	0.32
20	0.27

LOT AREA TABLE	
LOT #	AREA (AC)
21	0.33
22	0.31
23	0.24
24	0.32
25	0.32
26	0.26
27	0.31
28	0.34
29	0.37
30	0.37
31	0.36
32	0.32
33	0.29
34	0.25
35	0.28
36	0.31
37	0.31
38	0.33
39	0.27
40	0.33

REVISIONS		
NO.	DESCRIPTION/DATE	BY

ESM CONSULTING ENGINEERS, LLC
 33400 8th Ave S, Suite 205
 Federal Way, WA 98003
 (206) 839-4113
 (206) 297-9900
 www.esmcivil.com
 Civil Engineering | Land Surveying | Project Management | Land Planning | Landscape Architecture
 Public Works

NEW SUNCADIA LLC
 SUNCADIA PHASE 1 DIVISION 6
 PRELIMINARY PLAT
 KITITAS COUNTY WASHINGTON

JOB NO.:	1634-001-009
DWG. NAME:	PP-03
DESIGNED BY:	JJH
DRAWN BY:	LGB
CHECKED BY:	
DATE:	02/27/2017
PRINT DATE:	

SHEET
PP-03

Plotted: 2/22/2017 10:47 AM File: \\Esm8\engr\ESM\JOB5\1634\001\009\PP-03.dwg

A PORTION OF SECTIONS 19 & 20, TWP. 20 N., RGE., 15 E., W.M.,
KITITAS COUNTY, WASHINGTON

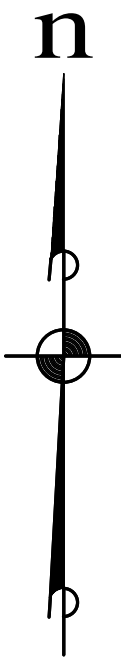
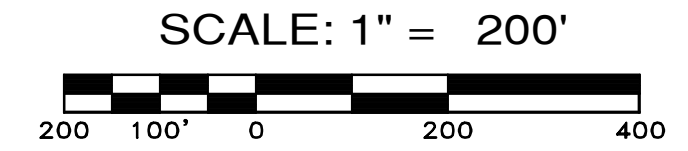

TRACT LEGEND

- OS OPEN SPACE
- S SERVICE
- AC ACCESS TRACT



REVISIONS		
NO.	DESCRIPTION/DATE	BY

ESM CONSULTING ENGINEERS, LLC
 33400 8th Ave S, Suite 205
 Federal Way, WA 98003
 FEDERAL WAY
 (253) 836-6113
 (253) 237-9900
 www.esmcivil.com
 Civil Engineering | Land Surveying | Project Management
 Public Works | Landscape Architecture

NEW SUNCADIA LLC
SUNCADIA PHASE 1 DIVISION 6
PRELIMINARY PLAT
 KITTITAS COUNTY WASHINGTON

JOB NO.:	1634-001-009
DWG. NAME:	PP-02
DESIGNED BY:	JJH
DRAWN BY:	LGB
CHECKED BY:	
DATE:	02/27/2017
PRINT DATE:	

SHEET
PP-02

Plotted: 2/22/2017 10:44 AM File: \\Esm\engr\ESM-JOB5\1634\001\009\PP-plat\Plots\PP-02.dwg

A PORTION OF SECTIONS 19 & 20, TWP. 20 N., RGE., 15 E., W.M.,
KITITAS COUNTY, WASHINGTON

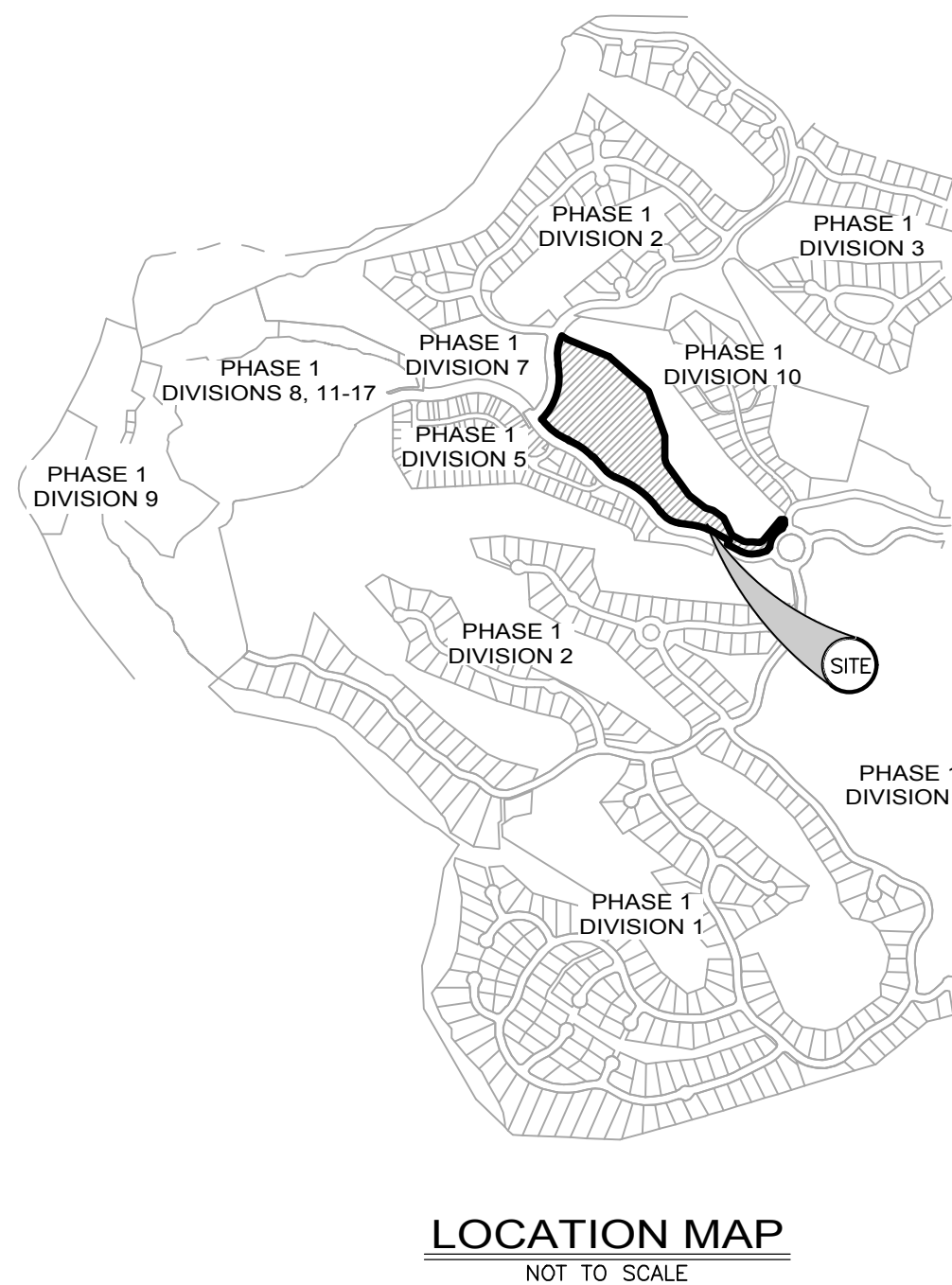
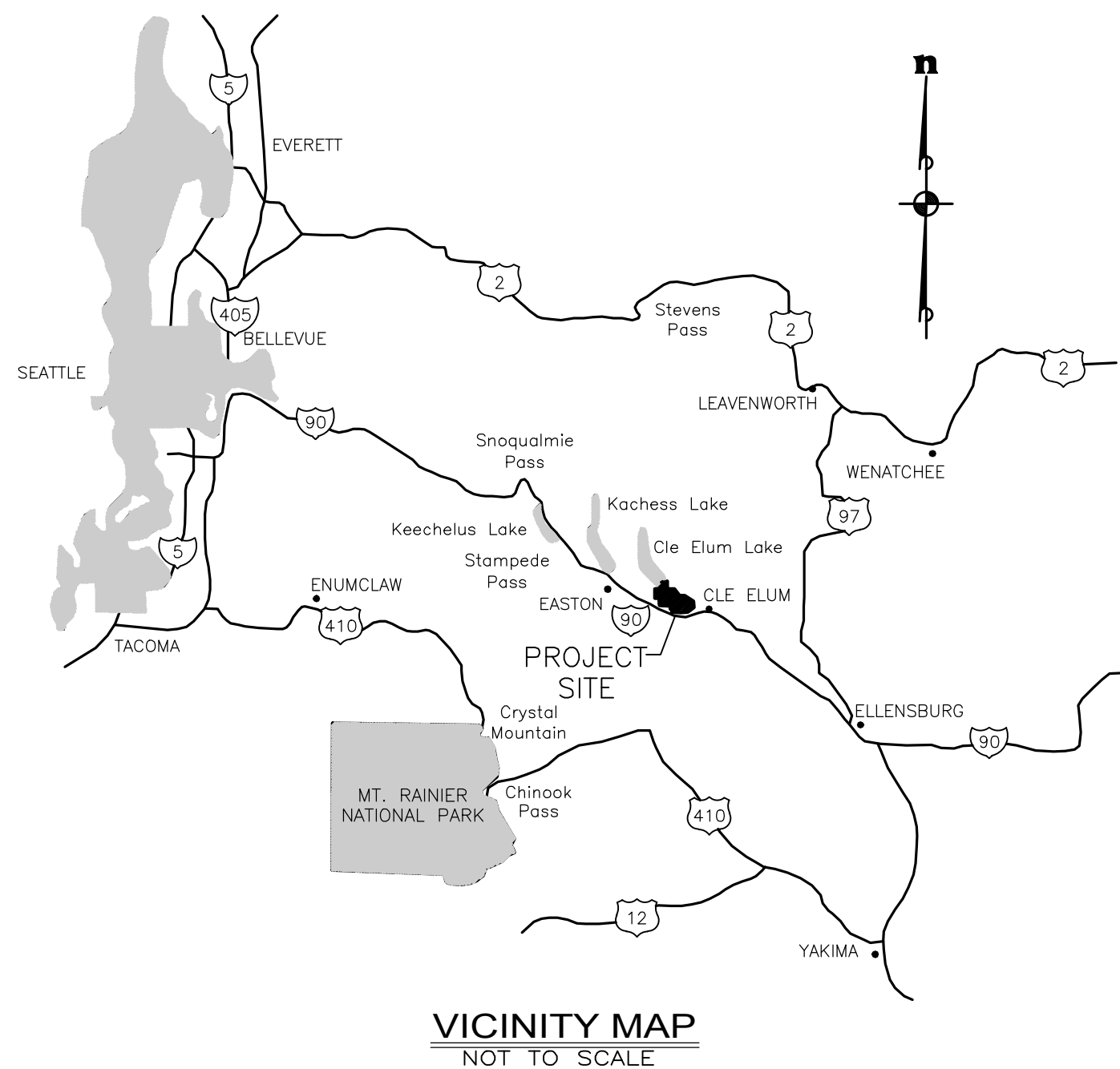

BASIS OF HORIZONTAL & VERTICAL DATUMS

BASIS OF HORIZONTAL DATUM:
WASHINGTON STATE PLANE COORDINATE SYSTEM, SOUTH ZONE, NAD83/91.
PROJECT IS REFERENCED VIA GPS TO NGS CONTROL POINTS "EASTON" (PID SX0662) AND "U358" (PID SX0459). THE DISTANCES SHOWN HEREIN ARE GROUND DISTANCES. TO CONVERT TO GRID DISTANCES, MULTIPLY BY A COMBINED AVERAGE SCALE FACTOR OF 0.999870387.

BASIS OF VERTICAL DATUM:
NGVD '29
BENCH MARK DISK L 525 1982, LOGO MARK - NGS NGVD 29 ELEVATION = 2026.05 LOCATION:
SET IN TOP NORTH END OF WEST CURB OF THE INTERSTATE 90 HIGHWAY OVERPASS ALONG STATE HIGHWAY 903.

OWNER

NEW SUNCADIA LLC, A DELAWARE LIMITED LIABILITY COMPANY
770 SUNCADIA TRAIL,
CLE ELUM, WASHINGTON 98922
TELEPHONE (509) 649-3000
FACSIMILE (509) 649-6251

GENERAL NOTES

VACATION HOMESITES RANGING IN SIZE FROM 0.24 ACRES TO 0.40 ACRES.

TOTAL ACREAGE PHASE 1, DIVISION 6 = 16.81 ACRES
TOTAL LOT ACREAGE = 12.47 ACRES
TOTAL NUMBER OF LOTS = 40
TOTAL NUMBER OF TRACTS = 6

WATER & SEWER NOTES

SEE PRELIMINARY SITE AND UTILITY ENGINEERING SUMMARY.

LEGAL DESCRIPTION

TRACT Z-2, PLAT OF "SUNCADIA PHASE 1 DIVISION 3", AUDITOR'S FILE NO. 200505040001, BEING A PORTION OF SECTIONS 19 AND 20, TOWNSHIP 20 NORTH, RANGE 15 EAST, W.M., KITITAS COUNTY, STATE OF WASHINGTON;

TOGETHER WITH THAT PORTION OF TRACT G-6 OF SAID PLAT, BEING MORE PARTICULARLY DESCRIBED AS FOLLOWS:

COMMENCING AT THE MOST EASTERLY CORNER COMMON TO SAID TRACTS;

THENCE ALONG THE LINE COMMON TO SAID TRACTS, N 24°54'00" W, 143.78 FEET TO THE TRUE POINT OF BEGINNING;

THENCE CONTINUING ALONG SAID COMMON LINE, N 56°06'11" W, 95.47 FEET;

THENCE CONTINUING ALONG SAID COMMON LINE, N 75°07'39" W, 58.98 FEET;

THENCE CONTINUING ALONG SAID COMMON LINE, N 51°53'18" W, 150.58 FEET;

THENCE CONTINUING ALONG SAID COMMON LINE, N 36°08'28" W, 142.74 FEET;

THENCE S 50°32'02" E, 438.26 FEET TO THE TRUE POINT OF BEGINNING.

CONTAINING 732,190 SQUARE FEET, MORE OR LESS.

TAX PARCEL NO.

20-15-20058-0184

REVISIONS		
NO.	DESCRIPTION/DATE	BY

ESM CONSULTING ENGINEERS, LLC
33400 8th Ave S, Suite 205
Federal Way, WA 98003
www.esmcivil.com
Civil Engineering | Land Surveying | Project Management | Public Works | Land Planning | Landscape Architecture

FEDERAL WAY STUDENT
(253) 838-4113
(253) 297-9600

NEW SUNCADIA LLC
SUNCADIA PHASE 1 DIVISION 6
PRELIMINARY PLAT
KITITAS COUNTY WASHINGTON

JOB NO.:	1634-001-009
DWG. NAME:	PP-01
DESIGNED BY:	JJH
DRAWN BY:	LGB
CHECKED BY:	
DATE:	02/27/2017
PRINT DATE:	
SHEET	
PP-01	

Plotted: 2/22/2017 10:42 AM File: \\Esm8\engr\ESM-JOB8\1634\001\009\PP-01.dwg

CHICAGO TITLE INSURANCE COMPANY

Policy No. 72156-45618085

GUARANTEE

CHICAGO TITLE INSURANCE COMPANY, a Nebraska corporation, herein called the Company, guarantees the Assured against actual loss not exceeding the liability amount stated in Schedule A which the Assured shall sustain by reason of any incorrectness in the assurances set forth in Schedule A.

1. No guarantee is given nor liability assumed with respect to the identity of any party named or referred to in Schedule A or with respect to the validity, legal effect or priority of any matter shown therein.
2. The Company's liability hereunder shall be limited to the amount of actual loss sustained by the Assured because of reliance upon the assurance herein set forth, but in no event shall the Company's liability exceed the liability amount set forth in Schedule A.

PLEASE NOTE CAREFULLY THE LIABILITY EXCLUSIONS AND LIMITATIONS AND THE SPECIFIC ASSURANCES AFFORDED BY THIS GUARANTEE. IF YOU WISH ADDITIONAL LIABILITY, OR ASSURANCES OTHER THAN AS CONTAINED HEREIN, PLEASE CONTACT THE COMPANY FOR FURTHER INFORMATION AS TO THE AVAILABILITY AND COST.

Dated: February 7, 2017

Issued by:
AmeriTitle, Inc.
101 W Fifth
Ellensburg, WA 98926
(509)925-1477



Authorized Signer

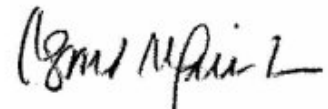

CHICAGO TITLE INSURANCE COMPANY

By: 
President

ATTEST

Secretary

Note: This endorsement shall not be valid or binding until countersigned by an authorized signatory.

Subdivision Guarantee Policy Number: 72156-45618085

SUBDIVISION GUARANTEE

Order No.: 154191AM
Guarantee No.: 72156-45618085
Dated: February 7, 2017

Liability: \$1,000.00
Fee: \$350.00
Tax: \$28.70

Your Reference: Tract Z-2 and portion of Tract G-6

Assured: New Suncadia, LLC and ESM Consulting Engineers, LLC

The assurances referred to on the face page are:

That, according to those public records with, under the recording laws, impart constructive notice of matters relative to the following described real property:

Tract Z-2, plat of "Suncadia Phase 1 Division 3", Auditor's File No. 200505040001, being a portion of Sections 19 and 20, Township 20 North, Range 15 East, W.M., Kittitas County, State of Washington;
Together with that portion of Tract G-6 of said plat, being more particularly described as follows:

Commencing at the most Easterly corner common to said Tracts;

Thence along the line common to said Tracts, North 24°54'00" West, 143.78 feet to the true point of beginning;

Thence continuing along said common line, North 56°06'11" West, 95.47 feet;

Thence continuing along said common line, North 75°07'39" West, 58.98 feet;

Thence continuing along said common line, North 51°53'18" West, 150.58 feet;

Thence continuing along said common line, North 36°08'28" West, 142.74 feet;

Thence South 50°32'02" East, 438.26 feet to the true point of beginning.

Title to said real property is vested in:

Tract Z-2: New Suncadia LLC, a Delaware limited liability company.

Portion of Tract G-6: New Suncadia Hospitality, LLC, a Delaware limited liability company

END OF SCHEDULE A

(SCHEDULE B)

Order No: 154191AM
Policy No: 72156-45618085

Subject to the matters shown below under Exceptions, which Exceptions are not necessarily shown in the order of their priority.

EXCEPTIONS:

1. Taxes or assessments which are not shown as existing liens by the records of any taxing authority that levies taxes or assessments on real property or by the public records.
2. Unpatented mining claims; reservations or exceptions in the United States Patents or in Acts authorizing the issuance thereof; water rights, claims or title to water.
3. Title to any property beyond the lines of the real property expressly described herein, or title to streets, roads, avenues, lanes, ways or waterways on which such real property abuts, or the right to maintain therein vaults, tunnels, ramps, or any other structure or improvement; or any rights or easements therein unless such property, rights or easements are expressly and specifically set forth in said description.
4. Any lien for service, installation, connection, maintenance, tap, capacity or construction or similar charges for sewer, water, electricity, natural gas or other utilities, or for garbage collection and disposal not shown by the Public Records
5. Indian tribal codes or regulations, Indian treaty or aboriginal rights, including easements or equitable servitudes.
6. General Taxes and Assessments – total due may include fire patrol assessment, weed levy assessment and/or irrigation assessment, if any. Taxes noted below do not include any interest or penalties which may be due after delinquency.

Note: Tax year runs January through December with the first half becoming delinquent May 1st and second half delinquent November 1st if not paid. For most current tax information or tax printouts visit: or call their office at (509) 962-7535.

Tax Year: 2017
Tax Type: County
Total Annual Tax: \$37,616.07
Tax ID #: 21930
Taxing Entity: Kittitas County Treasurer
First Installment: \$18,808.04
First Installment Status: Due
First Installment Due/Paid Date: April 30, 2017
Second Installment: \$18,808.03
Second Installment Status: Due
Second Installment Due/Paid Date: October 31, 2017
Affects: Tract Z-2

7. Tax Year: 2017
Tax Type: County
Total Annual Tax: \$1,791.56
Tax ID #: 11864
Taxing Entity: Kittitas County Treasurer
First Installment: \$895.78
First Installment Status: Due
First Installment Due/Paid Date: April 30, 2017
Second Installment: \$895.78
Second Installment Status: Due
Second Installment Due/Paid Date: October 31, 2017
Affects: Portion of Tract G-6

8. Liens, levies and assessments of the Community Enhancement as setforth in Second Amended and Restated Covenant recorded July 20, 2004, under Auditor's File No. 200407200039, in the amount of 0.5% of the gross purchase price payable upon any transfer of ownership, unless the transfer is exempt as provided in said covenant..

Said instrument provides for the lien of a fee which is due upon transfer of the Land. The transfer-conveyance fee is required to be paid upon any sale, exchange, assignment, option, assignment of lease, transfer, or conveyance of said Land.

9. Assessment in the amount of \$3,900 as setforth in Agreement and Covenant for Collection and Payment of Combined Qualification Payment for Extension of Natural Gas Service, between Mountainstar Resort Development, LLC and Puget Sound Energy, Inc., including the terms and provisions contained therein, recorded April 16, 2004, under Auditor's File No. 200404160016.
10. At the request of the insured, we have agreed to eliminate any reference in the policy to issue as to the pendency of Yakima County Superior Court Cause No. 77-2-01484-5 on the agreed-upon understanding that there are no provisions in said policy which afford, or are intended to afford, insurance that there is a present or continuing right to use surface waters of the Yakima River Drainage Basin. The sole purpose of said paragraph appearing in our Guarantee was to advise the insured that such an action is pending of record and that judgment adjudicating such surface waters are being sought in accordance with the statutes of the State.
11. Reservation of Oil, gas, minerals, or other hydrocarbons, including the terms and provisions contained therein, in deed from Plum Creek Timber Company, L.P., a Delaware Limited Partnership.

Recorded: October 11, 1996
Instrument No.: 199610110015

The Company makes no representation as to the present ownership of any such interests. There may be leases, grants, exceptions or reservations of interests that are not listed.

"Excepting therefrom all oil, gas and other hydrocarbons, together with the rights of ingress and egress as reserved in that certain Deed to Plum Creek Timber Company, L.P., from PCTC, Inc. executed on June 21, 1989 and recorded June 30, 1989 in the records of Kittitas County, Washington under Auditor's File No. 521473, as such reservation was modified by the certain Partial Waiver of Surface Use Rights dated February 13, 1996 and recorded April 8, 1996, in the records of Kittitas County, Washington, under Auditor's File No. 199604080028;

12. Agreement and the terms and conditions contained therein
Between: Kittitas County, a Washington municipal corporation
Subdivision Guarantee Policy Number: 72156-45618085

And: Suncadia LLC, a Delaware Limited Liability Company
Purpose: Amended and Restated Development Agreement
Recorded: April 16, 2009
Instrument No.: 200904160090

Resolution No. 2009-78 adopting the Seventh Amendment to Development Agreement, and the terms and conditions thereof, recorded June 12, 2009, under Auditor's File No. 200906120039.

13. Agreement and the terms and conditions contained therein
Between: Mountainstar Resort Development, LLC
And: Puget Sound Energy, Inc.
Purpose: Agreement and Covenant for Collection and Payment of Combine Qualification Payment for Extension of Natural Gas Service
Recorded: April 16, 2004
Instrument No.: 200404160016
14. Any rights, interests, or claims which may exist or arise by reason of the following matters(s) disclosed by Suncadia Phase I, Division 3, in Book 9 of Plats, pages 94 through 120,
Recorded: May 4, 2005
Book: Page:
Instrument No.: 200505040001
Matters shown:
 - a) Notes 1 through 9 thereon
 - b) Dedication thereon
 - c) 30 foot additional right of way (Suncadia Trail)
15. An easement including the terms and provisions thereof for the purpose shown below and rights incidental thereto as set forth in instrument:
Granted To: Suncadia Environmental Company, LLC, a Washington limited liability company
Purpose: Underground pipes and reservoir facilities
Recorded: February 20, 2007
Instrument No.: 200702200082
16. An easement including the terms and provisions thereof for the purpose shown below and rights incidental thereto as set forth in instrument:
Granted To: Suncadia Environmental Company, LLC, a Washington limited liability company
Purpose: Storm Drainage and Utilities
Recorded: April 30, 2007
Instrument No.: 200704300030
17. An easement including the terms and provisions thereof for the purpose shown below and rights incidental thereto as set forth in instrument:
Granted To: Puget Sound Energy, Inc., a Washington corporation
Purpose: Transmission, distribution and sale of electricity and natural gas
Recorded: January 27, 2010
Instrument No.: 201001270024
Affects: 10 foot strip adjoining all roads shown on the plat
18. A Deed of Trust, including the terms and provisions thereof, to secure the amount noted below and other amounts secured thereunder, if any:
Amount: \$6,000,000.00

Trustor/Grantor: New Suncadia Hospitality, LLC, a Delaware limited liability company
Trustee: AmeriTitle
Beneficiary: Bank of the Cascades
Dated: March 29, 2016
Recorded: March 30, 2016
Instrument No.: 201603300033
Affects: Tract G-6 and other land

19. A Deed of Trust, including the terms and provisions thereof, to secure the amount noted below and other amounts secured thereunder, if any:
Amount: \$4,000,000.00
Trustor/Grantor: New Suncadia Hospitality, LLC, a Delaware limited liability company
Trustee: AmeriTitle
Beneficiary: Bank of the Cascades
Dated: March 30, 2016
Recorded: March 30, 2016
Instrument No.: 201603300034
Affects: Tract G-6 and other land
(Said Deed of Trust is a Line of Credit Deed of Trust)
20. Assignment of Rents, including the terms and provisions thereof:
Grantor: New Suncadia Hospitality, LLC, a Delaware limited liability company
Lender: Bank of the Cascades, an Oregon State chartered bank
Recorded: March 30, 2016
Instrument No.: 201603300035
Affects: Tract G-6 and other land

END OF EXCEPTIONS

Notes:

- a. All documents recorded in Washington State must include an abbreviated legal description and tax parcel number on the first page of the document. The abbreviated description for this property is: Tract Z-2 and portion of Tract G-6, Suncadia Phase 1 Division 3, Book 9 of Plats, pgs 94-120.

Note No. 1: Any map or sketch enclosed as an attachment herewith is furnished for informational purposes only to assist in property location with reference to streets and other parcels. No representation is made as to accuracy and the company assumes no liability for any loss occurring by reason of reliance thereon.

NOTE: In the event any contracts, liens, mortgages, judgments, etc. which may be set forth herein are not paid off and released in full, prior to or immediately following the recording of the forthcoming plat (short plat), this Company will require any parties holding the beneficial interest in any such matters to join in on the platting and dedication provisions of the said plat (short plat) to guarantee the insurability of any lots or Subdivision Guarantee Policy Number: 72156-45618085

parcels created thereon. We are unwilling to assume the risk involved created by the possibility that any matters dedicated to the public, or the plat (short plat) in its entirety, could be rendered void by a foreclosure action of any such underlying matter if said beneficial party has not joined in on the plat (short plat).

END OF GUARANTEE

Auditor's File No.

20050504001

SUNCADIA PHASE 1 DIVISION 3

Pln. E 1/2, SEC. 19, Pln. SEC. 20, Pln. W 1/2, SW 1/4, SEC. 21,
Pins. NW 1/4, NW 1/4 SEC. 28 & NE 1/4, NE 1/4, SEC. 29, TWP. 20 N., R. 15 E., W.M.
KITTITAS COUNTY WASHINGTON

See Sheet 22

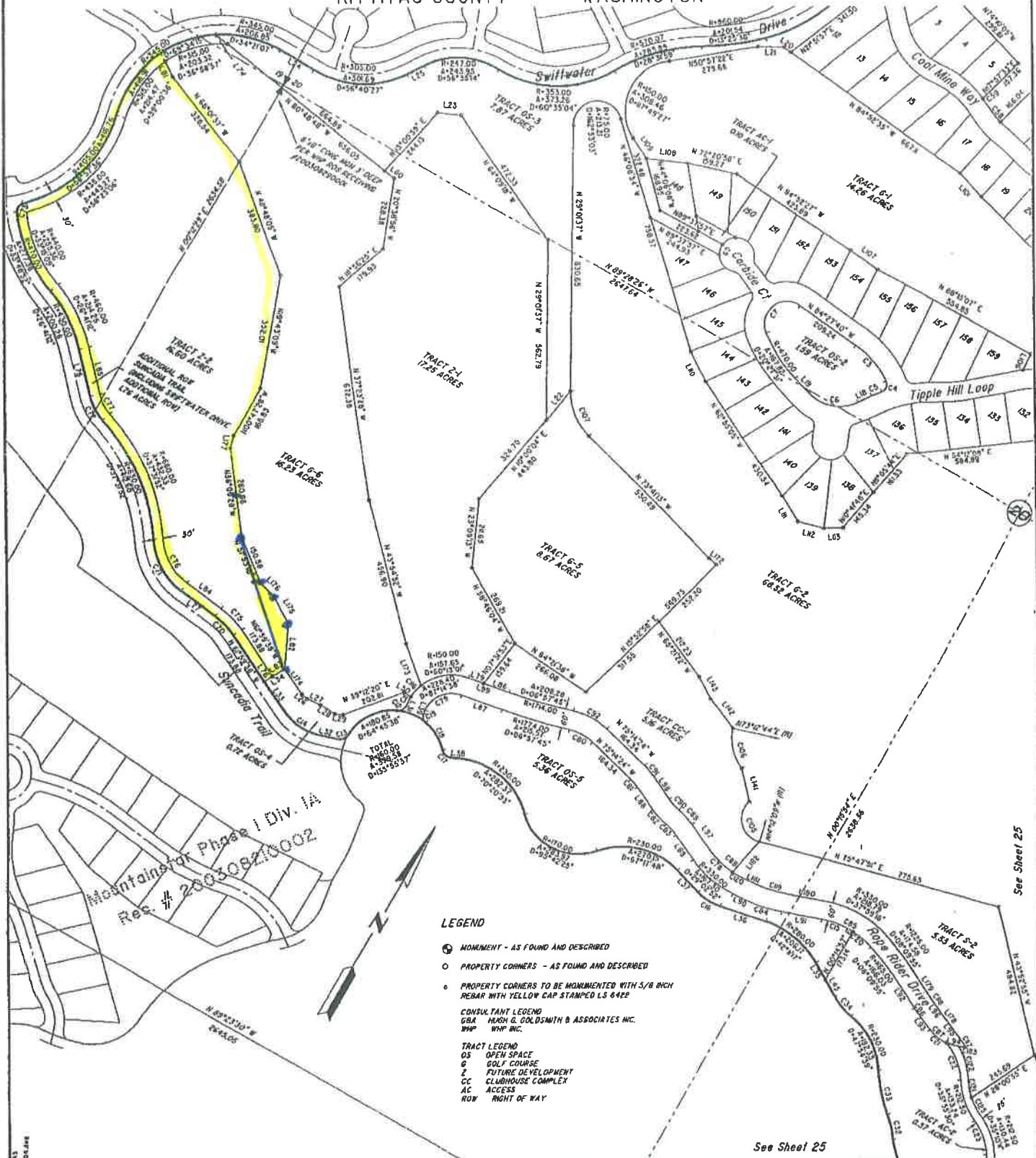

Mountaintop Phase 1 Div. 1A
Reg. # 200308210002

- LEGEND**
- ⊙ MONUMENT - AS FOUND AND DESCRIBED
 - PROPERTY CORNERS - AS FOUND AND DESCRIBED
 - PROPERTY CORNERS TO BE MONUMENTED WITH 5/8 INCH REBAR WITH YELLOW CAP STAMPED LS 6422
- CONSULTANT LEGEND**
- GBA HENSH G. GOLDSMITH & ASSOCIATES INC.
 - WHP WHP INC.
- TRACT LEGEND**
- OS OPEN SPACE
 - G GOLF COURSE
 - Z FUTURE DEVELOPMENT
 - CC CLUBHOUSE COMPLEX
 - AC ACCESS
 - ROW RIGHT OF WAY

See Sheet 25

See Sheet 25

SCALE 1" = 200'



GOLDSMITH & ASSOCIATES
 Since 1938 Engineering - Land Use Planning - Surveying

1215 114th Avenue SE, Bellevue, WA 98004, P.O. Box 3563, Bellevue, WA 98009
OFFICE: (425) 462-1080, FAX: (425) 462-7719, staff@goldsmithengineering.com